

Clamp  
Operating Instruction  
VMC-1



1. Introduction

VMC-1 series are 4000-count hand-held clamp meters with auto range. The meter is designed with ergonomic structure and overload protection for all ranges, which make it a superior tool for electricians. VMC-1 series can measure AC/DC voltage, AC current, resistance, diode, continuity, capacitance, temperature and perform data hold, max/min measurement, relative value measurement, NCV, low battery indication, audio/visual alarm and auto power off functions.

Please read the "safety guidelines" and "warnings" in this manual carefully before use and strictly observe the precautions.

**Warning:**  
Please read the "safety guidelines" carefully before using the meter.

2. Open Box Inspection

Open the package box and take out the device. Please check whether the following items are deficient or damaged, and contact your supplier immediately if they are.

- 1) User manual 1pc
- 2) Test leads 1 pair
- 3) Type K temperature probe 1pc
- 4) Cloth bag 1pc
- 5) Certificate of approval 1pc

3. Safety Guidelines

Please pay attention to "⚠". A warning indicates conditions or actions that may pose hazards to the user, or cause damage to the meter or equipment under test.

This meter complies with IEC/EN61010-1, 61010-2-032, EN61326-1, double insulation, CAT II 600V, CAT III 300V and pollution grade II safety standards.

Please use the meter only as specified in this manual, otherwise the protection provided by the meter may be impaired.

- 1) Check the clamp meter and the test leads before use. Do not use the meter if the test leads, insulation layer of the case appear damaged, or if there is no display on the screen, or if you suspect that the meter is not operating properly.
- 2) Do not use the meter if the rear cover or the battery cover are not covered up or it will pose a shock hazard.
- 3) Keep the fingers behind the finger guard during operation. Do not touch the bare wires, connectors, unused input terminals or the circuits being measured to prevent electric shock.

- 4) Switch the functional dial to the correct position before measuring. It is strictly forbidden to switch the dial when measuring to avoid damage to the meter.
  - 5) Do not input >600V AC/DC voltage between meter terminal and ground to avoid electric shock and damage to the meter.
  - 6) When measuring AC/DC voltage>30V, please operate carefully according to this user manual or it may pose a shock hazard.
  - 7) Do not measure voltage or current which is higher than the rated value. If the measuring range is unknown, please switch the functional dial to the maximum range. Before measuring the resistance, diode or continuity on line, switch off the power supply of the circuit and fully discharge all capacitors, otherwise the measurement result might be incorrect.
  - 8) To ensure accuracy, replace the battery in time when "⚠" appears on the screen. Take out the batteries if the meter is not used for a long time.
  - 9) Do not change the internal wiring of the meter to avoid damage to the meter and personal injury.
  - 10) Do not use or store the meter in high temperature, high humidity, flammable, explosive and strong electromagnetic environments.
- Clean the case with a soft cloth and mild detergent. Do not use abrasives or solvents to prevent corrosion and to avoid damage to the meter and personal injury.

4. Electrical Symbols

Symbol	Description	Symbol	Description
	High voltage hazard		Double insulation
	AC		Grounding
	DC		Warning
	Conforms to European Union standards		

5. General Specifications

- LCD display: 4099 max
- Polarity display: auto positive and negative polarity display
- Overload display: "OL" or "-OL"
- Low battery indication: "⚠" symbol appears, please replace with new batteries.

- Measurement deviation: if the conductor being measured is not placed in the center of the jaw during current measurement, it will cause extra ±1.0% reading error.
- Drop test: 1m drop test passed
- Max jaw opening: 28 mm diameter
- Max current conductor size: 28mm diameter
- Power supply: AAA 1.5V battery x2

- Auto power off: The meter will automatically shut down if the dial is not switched or the buttons are not pressed in about 15 minutes. This function can be turned off as required.
- Dimension: 220mm×77mm×29.5mm
- Weight: about 272g (including batteries)
- Altitude: 2000m
- Operating temperature and humidity: 0°C~30°C (≤80%RH), 30°C~40°C (≤75%RH), 40°C~50°C (≤45%RH)
- Storage temperature and humidity: -20°C~+60°C (≤80%RH)
- EMC: RF field (1V/m): overall accuracy = specified accuracy + 5% of range  
RF field (>1V/m): no specified calculation

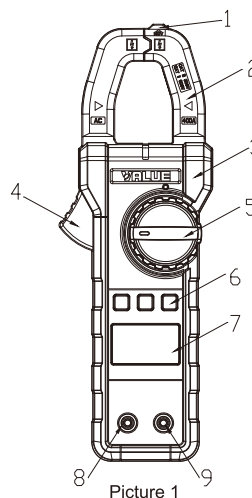

Picture 1

6. External Structure (picture 1)

- 1) NCV sensing part
- 2) Jaws: AC current sensor
- 3) Hand guards: protect user's hand from touching the dangerous area.
- 4) Trigger: press the trigger to open the jaws; release the trigger and the jaws will close automatically.
- 5) Functional dial: select functions
- 6) Functional buttons: select/switch functions or modes
- 7) LCD display: displays measured data and symbols.
- 8) Common input terminal (COM): connects the black test lead or the negative end of the temperature probe.
- 9) Signal input terminal: connects the red test lead or the positive end of the temperature probe.

7. LCD Display (picture 2)

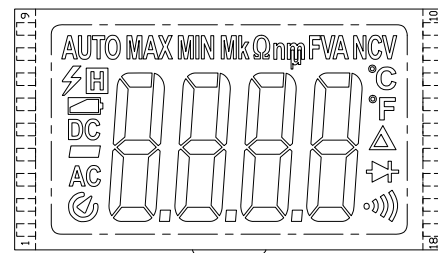

Picture 2 NMC1/VMC-1 LCD display

1	AUTO	Auto range
2	MAX MIN	MAX/MIN measurement
3	MΩ Ω	Unit
4	NCV	Non-contact AC voltage sensing
5	°C °F	Temperature unit
6	⚠	Relative value indicator
7	↔	Diode
8	🔊	Continuity measurement
9	🔌	Auto power off
10	AC	AC signal
11	⚠	Negative indicator
12	DC	DC signal
13	🔋	Low battery indicator
14	📄	Data hold
15	⚡	High voltage indicator

8. Button Function

- 1) SELECT/REL: a) In a position with multiple functions, press SELECT/REL to switch between different functions. b) In capacitance position, press SELECT/REL to enter the relative value measurement mode.
- 2) HOLD/BACKLIGHT: a) Short press to enter/exit the data hold mode. b) Long press to turn on/off the backlight (within 15s). The backlight will be off automatically after 15 seconds while it is enabled.
- 3) MAX/MIN: Press once to enter the MAX measurement mode, LCD will display "MAX" symbol. Press the button again to enter the MIN measurement mode, LCD will display "MIN" symbol, and so on. Long press this button to exit MAX/MIN measurement. This function is valid only in AC/DC voltage, AC current, resistance and temperature measurement.

9. Technical Index

**Accuracy:** ±(% of reading + digits), please perform calibration once a year.  
**Ambient temperature and humidity:** 23°C±5°C; ≤80%RH.  
To ensure accuracy, the operating temperature should be within 18°C~28°C and the fluctuation range should be within ±1°C.  
Temperature <18°C or >28°C: add temperature coefficient error 0.1 x (specified accuracy) /°C.

9.1 AC Current

Range	Resolution	Accuracy	Overload protection
4.000A	0.001A	±(4%+20)	400A
40.00A	0.01A	±(3%+20)	
400.0A	0.1A	±(2.0%+10)	

- Frequency response: 50Hz~60Hz
- 4A range: open circuit allows least significant digit <5.
- Accuracy guarantee range: 5~100% of range

9.2 AC Voltage

Range	Resolution	Accuracy	Overload protection
4.000A	0.001A	±(0.7%+5)	600V Vrms
40.00A	0.01A	±(1.0%+3)	
400.0A	0.1A		
600V	1V		

- Input impedance ≥10MΩ
- Frequency response: 40~400Hz
- Accuracy guarantee range: 5~100% of range

9.3 DC Voltage

Range	Resolution	Accuracy	Overload protection
400.0mV	0.1mV	±(0.7%+3)	600V Vrms
4.000V	0.001V	±(0.5%+2)	
40.00V	0.01V	±(0.7%+3)	
400.0V	0.1V		
600V	1V		

- Input impedance ≥10MΩ
- mV range: short circuit allows ≤5 digits. Other ranges: return to zero when short-circuited.
- Accuracy guarantee range: 1~100% of range

9.4 Resistance

Range	Resolution	Accuracy	Overload protection
400.0Ω	0.1Ω	±(1.0%+2)	600V Vrms
4.000kΩ	0.001kΩ	±(0.8%+2)	
40.00kΩ	0.01kΩ		
400.0kΩ	0.1kΩ	±(2.5%+5)	
4.000MΩ	0.001MΩ		
40.00MΩ	0.01MΩ		

9.5 Continuity

Range	Resolution	Accuracy	Overload protection
400.0Ω	0.1Ω	±10Ω buzzer on ≥50Ω buzzer off	600V Vrms
Open circuit voltage: about 2.0V			

9.6 Diode

Range	Resolution	Accuracy	Overload protection
4.000V	0.001V	Open circuit voltage: about 2.2V. Can measure PN junction about ±2V (forward voltage drop). Silicon PN junction normal voltage: about 0.5~0.8V	600V Vrms

9.7 Capacitance

Range	Resolution	Accuracy	Overload protection
4.000nF	0.001nF	±(4.0%+10)	600V Vrms
40.00nF	0.01nF		
400.0nF	0.1nF	±(4.0%+5)	
4.000μF	0.001μF		
40.00μF	0.01μF		
400.0μF	0.1μF		
4.000mF	0.001mF	±(10%)	

• Measurement result = reading of capacitance – reading of open test leads (Measured capacitance ≤100nF: REL mode is recommended)

• There is a residual reading (intrinsic capacitance) in open circuit.

9.8 Temperature

Range	Resolution	Accuracy	Overload protection
-40°C~40°C	1°C	±4°C	600V Vrms
40°C~400°C		±(1.5%+5)	
400°C~1000°C		±(2.0%+5)	
-40°F~104°F	1°F	±6°F	
104°F~752°F		±(2.0%+6)	
752°F~1832°F		±(2.5%+4)	

9.9 NCV

Range	Non-contact electric field sensing condition	Accuracy
NCV	Power frequency voltage: about 100V (50Hz/60Hz)	1. Press SELECT to switch to NCV function. 2. Place the NCV sensing part on the clamp head near the measured object (about ≤15mm). If the measured electric field voltage is ≥42V, LCD will display "EF". If >100V, LCD will display segments such as "-" or "- - -". According to the intensity of the electric field, the buzzer beeps and the red LED flashes with varied frequencies. The higher the electric field intensity, the higher the buzzer frequency, and the higher the red LED flashing frequency. 16mm~80mm: buzzer on or off. >80mm: buzzer off.

10. Operation Instructions

10.1 AC Current Measurement (picture 3)

- 1) Select AC current range (4A~, 40A~/400A~)
- 2) Open the jaws and place the wire in the center (single wire), make sure the jaws are completely closed and there is no gap between them.
- 3) The meter can only measure one current conductor at a time. If two or more current conductors are measured at the same time, the readings are wrong.

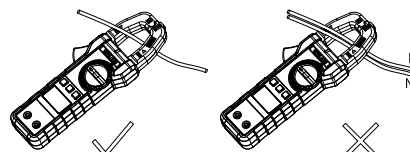

Picture 3

Notes:

- The current measurement must be operated between 0°C~40°C. Hold the trigger and do not release it suddenly. The meter is very sensitive to mechanical stress. Any impact will cause change to the reading in a short time.
- To ensure accurate measurement result, place the conductor being measured in the center of the jaw, otherwise it will cause extra ±1.0% reading error.
- Measured current ≥ AC 400A: The meter will alarm automatically and the high voltage warning symbol ⚡ will flash automatically.
- Measured current > 420A (max): If "OL" appears, stop testing and use a meter with larger range to measure, or it may cause damage to the meter.

10.2 AC/DC Voltage Measurement

- 1) Insert the red test lead to the "signal input" terminal, black to "COM" terminal.
- 2) Switch the dial to AC voltage position, and connect the test probes with the source or the load in parallel.

Notes:

- Do not input voltage higher than AC 600V. It is possible to measure higher voltage. However, it may cause damage to the meter.
- Be cautious to avoid electric shock when measuring high voltage.
- Measured voltage ≥ 30V/AC (safe voltage): The high voltage warning symbol ⚡ will appear on LCD.
- Measured voltage ≥ 600V/ AC: The meter will alarm automatically and the high voltage warning symbol ⚡ will flash automatically.

10.3 Resistance Measurement

- 1) Insert the red test lead to the "signal input" terminal, black to "COM" terminal.
- 2) Switch the dial to "Ω" position and press SELECT to select resistance measurement, then connect the test probes with the resistor in parallel.

Notes:

- If the measured resistor is open or the resistance exceeds the maximum range, the "OL" symbol will appear on the screen.
- Before measuring the resistance on line, switch off the power supply of the circuit, and fully discharge all capacitors.
- If the resistance is greater than 0.5Ω when the test leads are shorted, please check if the test leads are loose or damaged.
- Do not input voltage higher than DC/AC 30V to avoid personal injury.

10.4 Continuity Measurement

- 1) Insert the red test lead to the "signal input" terminal, black to "COM" terminal.
- 2) Switch the dial to "🔊" position and press SELECT to select continuity measurement "🔊", then connect the test probes with the loads in parallel. Measured resistance <10Ω: good conduction circuit, buzzer on (beeps continuously) Measured resistance ≥10Ω and ≤50Ω: buzzer on or off Measured resistance >50Ω: buzzer off

Notes:

- Before checking the continuity on line, switch off the power supply of the circuit, and fully discharge all capacitors.
- Continuity measurement: The open circuit voltage is about 2.0V and the range should be 400Ω.
- Do not input voltage higher than DC/AC 30V to avoid personal injury.

10.5 Diode Measurement

- 1) Insert the red test lead to the "signal input" terminal, black to "COM" terminal. The polarity of the red test lead should be "+" and the polarity of the black test lead should be "-".
- 2) Switch the dial to "➡" position and press SELECT to select diode measurement "➡", then read the forward PN junction voltage of the measured diode on the LCD. Silicon PN junction: about 500~800mV (normal value).

Notes:

- If the diode is open or its polarity is reversed, "OL" symbol will appear.
- Before measuring the diode on line, switch off the power supply of the circuit, and fully discharge all capacitors.
- Open circuit voltage: about >2.2V
- Do not input voltage higher than DC/AC 30V to avoid personal injury.

10.6 Capacitance Measurement

- 1) Insert the red test lead to "signal input" terminal, black to "COM" terminal.
- 2) Switch the dial to "-f" position and connect the test probes with the capacitor in parallel. Measured capacitance ≤100nF: It is recommended to measure in "REL" mode.
- 3) It is recommended to use short test leads for capacitance measurement to reduce the effect of distributed capacitance.

Notes:

- If the measured capacitor is short-circuited or the capacitance exceeds the maximum range, the "OL" symbol will appear on the screen.
- When measuring capacitance >400μF, it may take some time to obtain steady and accurate readings.
- To ensure measurement accuracy, please fully discharge all capacitors before measuring (especially for capacitors with high voltage) to avoid damage to the meter and personal injury.

10.7 Temperature Measurement

- 1) Insert the positive temperature probe to the "signal input" terminal, negative to "COM" terminal.
- 2) Switch the dial to "°C °F" position, LCD will display OL symbol. Short circuit the test probes to read the room temperature.
- 3) Attach the temperature probe to the surface of the measured object, read its temperature value from the LCD display after a few seconds.
- 4) Press SELECT button to switch between °F and °C

Notes:

- The ambient temperature must not exceed 18-28°C, otherwise it will cause measurement error.
- The positive and negative poles of the temperature probe should be correctly connected to the meter. Do not measure non-insulated live objects to prevent error reading.
- Do not input voltage higher than DC/AC 30V to avoid personal injury.

10.8 Non-contact AC Voltage Sensing (NCV, picture 4)

When the electric field is ≥100V AC 50Hz/60Hz, and the NCV sensing part on the clamp head is close to it (about ≤15mm), the buzzer will keep beeping and the red LED will flash, along with "N" segments appear on the LCD. According to the intensity of the electric field, the buzzer beeps and the red LED flashes with varied frequencies. The higher the electric field intensity, the higher the buzzer frequency, and the higher the red LED flashing frequency. 16mm~80mm: buzzer on or off. >80mm: buzzer off.

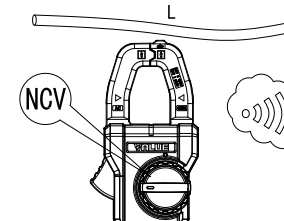

Picture4

Notes:

- Place the NCV sensing part on the clamp head near the measured electric field, otherwise the measurement sensitivity might be affected.
- Measured electric field ≥100V AC: pay attention to the insulation of the conductor in the electric field to avoid personal injury.

10.9 Others

- Auto power off: If there is no operation for 15 minutes, the meter will automatically shut down to save power. You can wake up the meter by pressing any button, or switch the dial to OFF and then restart the meter.
- To disable auto power off, switch the dial to OFF position, press the SELECT button and turn on the meter. You can restart the meter to restore the auto power off function.
- Buzzer: The buzzer will make a "beep" sound (about 0.25s) at any valid press or switch of the dial. When measuring voltage or current, the buzzer will also make intermittent "beep" sounds indicating over-range, as follows: a) AC/DC voltage measurement > about 600V b) AC/DC current measurement >400A

11. Maintenance (picture 5)

Warning:

Please remove the test leads before opening the bottom cover to avoid electric shock. Turn the meter OFF when it is not in use.

11.1 General Maintenance

- a. The maintenance and service must be implemented by qualified professionals or designated departments.
- b. Periodically clean the case with a dry cloth. Do not use detergents containing abrasives or solvents.

11.2 Battery Installation and Replacement

- Power supply: AAA 1.5V battery x 2
- a. Turn off the meter and remove the test leads from the input terminals.
  - b. Place the meter panel downward and loose the screw on the battery cover, remove the cover and replace the batteries according to the polarity indication.
  - c. Please replace the batteries with the same specifications.
  - d. After installing the new batteries, close the battery cover and tighten the screw.



# 让工作更轻松!

## 钳形表使用说明书 VMC-1



量程	分辨率	准确度	过载保护
400.0Ω	0.1Ω	≤10Ω蜂鸣器发声	600V Vrms
		≥50Ω蜂鸣器不发声 开路电压约2.0V	

量程	分辨率	准确度	过载保护
4.000V	0.001V	开路电压约2.2V 可测量PN结约≤2V 正向压降值。	600V Vrms
		硅PN结正常电压值 约为0.5~0.8V	

量程	分辨率	准确度	过载保护
4.000nF	0.001nF	±(1.5%+10)	600V Vrms
40.00nF	0.01nF	±(1.5%+5)	
400.0nF	0.1nF	±(2.0%+5)	
4.000uF	0.001uF	±(4.0%+5)	
40.00uF	0.01uF	±6°F	
400.0uF	0.1uF	±(2.0%+6)	
4.000mF	0.001mF	±(10%)	±(2.5%+4)

- 被测值=测量显示值-表笔开路值(≤100nF被测电容建议采用REL模式测量)；
- 开路约有残余读数；

量程	分辨率	准确度	过载保护
-40°C~40°C	1°C	±4°C	600V Vrms
40°C~400°C		±(1.5%+5)	
400°C~1000°C		±(2.0%+5)	
-40°F~104°F	1°F	±6°F	
104°F~752°F		±(2.0%+6)	
752°F~1832°F		±(2.5%+4)	

量程	非接触电场 感测条件	准确度
NCV	工频电压约 100V (50Hz/60Hz)	1.NCV功能通过SELECT切换 2.将钳头部位的NCV感测端靠近(约≤15mm) 电场物体,如被测电场电压≤42VpV LCD显 “EF”当>100V或更高时,LCD显“-”或 “-.-.-”多个横段,伴随着感测电场的强弱 蜂鸣声,红色LED会同步改变发声与发光闪烁 的频率,电场强度越大,蜂鸣器发声频率和 红色LED发光闪烁频率越高,16mm~30mm 可发声或不发声;>80mm感测不能发声

### 一、概述

VMC-1系列是4000计数、自动量程便携式手持钳表。具有全量程过载保护电路,独特的外观设计使之成为性能优越的专用电工仪表。可用于测量:交直流电压、交流电流、电阻、二极管、电路通断、电容、温度等参数,并具有数据保持、最大/最小值测量、相对值测量、NCV功能、欠压显示、报警提示、报警声提示和自动关机功能。请仔细阅读本说明书中包括的有关“安全”和“警告提示”的相关内容,并严格遵守所有警告的注意事项。

**警告:**  
在使用产品之前,请仔细阅读有关“安全操作准则”。

### 二、开箱检查

打开包装盒,取出仪表,请仔细检查下列项目是否缺少或损坏:

1. 使用说明书一本
2. 表笔一副
3. K型温度探头一条
4. 布包一个
5. 合格证一张

如果发现任何一个项目缺少或损坏,请立即与您所购买的供应商进行联系。

### 三、安全操作准则

请注意“警告标识及警告字句”。警告表示对使用者构成危险,对仪表或被测设备可能造成损坏的情况或行动。

本仪表通过IEC/EN61010-1,61010-2-032,电磁辐射EN61326-1安全标准认证,符合双重绝缘、过电压CAT II 600V、CAT III 300V和污染等级2的安全标准。如果未能按照有关的操作说明使用,则可能会削弱或失去仪表为您所提供的保护能力。

1. 使用前应检查钳表和表笔,谨防任何损坏或不正常的现象。如发现表笔、壳体绝缘已明显损坏以及液晶显示器无显示等,或者您认为仪表已无法正常工作,请勿再使用。
2. 后盖及电池盖没有盖好前严禁使用仪表,否则有电击危险。
3. 在进行测量时,切记手指不要超过表笔握手部位,不要接触裸露的电线、连接器、没有使用的输入端或正在测量的电路,防止触电。
4. 测量前,功能开关必须置于正确位置,严禁在测量进行中转换档位,以防损坏仪表。

### 十、测量操作说明

1. **交流电流测量(见图3)**
  - 1) 选定交流电流量程(4A~、40A~/400A~)
  - 2) 打开钳头,钩上电线(单线),注意确保钩部应完全闭合,两钩之间不可有间隙。
  - 3) 仪表一次只能测量一个电流导体,若同时测量两个或以上的电流导体,测量读数是错误的。



图3

#### 注意

- 电流测量功能必须在0°C~40°C之间操作,按住扳机不要突然松开,仪表测量对机械应力均有不同程度的敏感,撞击会短时间引起读数变化。
- 为保证测量数据准确,须将被测导体位于钳头的中央,未置于钳头中心位置会产生±1.0%读数附加误差。
- 当测量电流大于≥AC 400A时仪表会自动发出报警声且高压报警提示符“⚡”会自动闪烁,以作报警提示。
- 对于测量大于仪表最大电流(420A)的情况下,仪表已经显示“OL”时,应避免继续测试下去,如长时间测试下去有损坏仪表的危险,此时应更换更大量程的仪表来测量。

#### 2. 交/直流电压测量

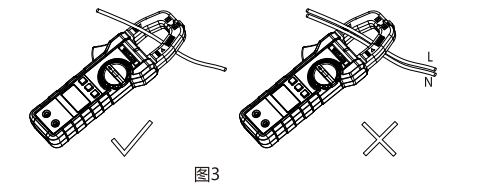
- 1) 将红表笔插入“测量信号输入端口”插孔,黑表笔插入“COM”插孔。
- 2) 将功能量程开关置于交流电压测量档,并将表笔并连到待测电源或负载上。

#### 注意

- 不要输入高于AC 600V 的电压。测量更高的电压是有可能的,但有损坏仪表的危险。
- 在测量高电压时,要特别注意避免触电。
- 被测电压≥30V/AC安全电压时,本仪表LCD显示高压警告提示符“⚡”,当测量电压≥AC 600V时仪表会自动发出报警声且高压报警提示符“⚡”会自动闪烁。

#### 3. 电阻测量

- 1) 将红表笔插入“测量信号输入端口”插孔,黑表笔插入“COM”孔。
- 2) 将功能开关置于“Ω”测量档,按SELECT键选择电阻测量,并将表笔并联到被测电阻两端上。

5. 不要在仪表终端及接地之间施加>600V以上的交直流电压,以防电击和损坏仪表。
6. 当仪表在测量>30V以上的交直流电压时,应依照操作说明书安全操作,使用不当会有电击危险的存在。
7. 不要测量高于允许输入值的电压或电流,在不能确定被测量的范围时,须将功能量程开关置于最大量程位置。进行在线电阻、二极管或电路通测量之前,必须先将被电路中所有电源切断,并将所有电容器放电,否则会导致测量结果不准确。
8. 当液晶显示器显示“☹”标志时,应及时更换电池,以确保测量精度。仪表长期不用时,应取出电池。
9. 请勿随意改变仪表内部接线,以免损坏仪表和危及安全。
10. 不要在高温、高湿、易燃、易爆和强电磁场环境中存放及使用本仪表。
11. 维护保养请使用柔软布及中性清洁剂清洁仪表外壳,切勿使用研磨剂及溶剂,以防外壳被腐蚀,以免损坏仪表、危及安全。

### 四、电气符号

符号	含义说明	符号	含义说明
	高压危险		双重绝缘
	AC(交流)		接地
	DC(直流)		警告提示
	符合欧洲共同体(European Union)标准		

### 五、综合特性

- LCD显示:** 最大显示至4099;  
**极性显示:** 自动正负极性显示;  
**过载显示:** 以“OL”或“-OL”显示;  
**电池低电压显示:** “☹”符号显示,表示电池电压低于工作电压,需更换新电池;  
**测试位置误差:** 测量电流时因为未将待测源置于钳头中心位置会产生±1.0%读数附加误差;  
**耐冲击强度:** 可承受1m高度落地撞击;  
**钳头开启最大尺寸:** 直径 28 mm;  
**预测电流导线最大尺寸:** 直径 28 mm;  
**电源供给:** 2节AAA 1.5V电池;  
**自动关机功能:** 在约15分钟内均无量程开关拨动或按键按下时仪表自动关机,也可根据需要关闭该功能;  
**尺寸:** 220mm×77mm×29.5mm;  
**重量:** 约272g(包括电池);

- 海拔高度:** 2000米;  
**操作温湿度:**  
 0°C~30°C(不大于80%RH),  
 30°C~40°C(不大于75%RH),  
 40°C~50°C(不大于45%RH);  
**储存温湿度:** -20°C~+60°C(不大于80%RH);  
**电磁兼容性:** 在1V/m的射频场下:总精度=指定精度+量程的5%,超过1V/m以上的射频场设有指定指标。

### 六、外表结构(见图1)

1. NCV感测端点。
2. 钳头,测量交流电流的传感装置。
3. 钳身,为保护使用者手部接触到危险区的一种安全设计。
4. 钳头扳动手柄,按压扳机使钳头张开;松开扳机则钳头自动闭合。
5. 转盘开关,测量功能档位的选择。
6. 功能按键,用于选择和切换测量功能和测量模式。
7. LCD显示区,测量数据及功能符号显示。
8. 测量输入公共端(COM),接黑表笔和温度探头的负极端。
9. 测量信号输入端口,接红表笔和温度探头的正极端。



图1

### 注意

- 如果被测电容短路或容值超过仪表的最大量程时,显示器将显示“OL”。
- 对于大于400μF电容的测量,需要一定的读数稳定时间,便于正确读数。
- 为了确保测量精度,建议电容在测试前将电容全部放尽残余电荷后再输入仪表进行测量,对带有高压的电容更为重要,避免损坏仪表和伤及人身安全。

#### 7. 温度测量

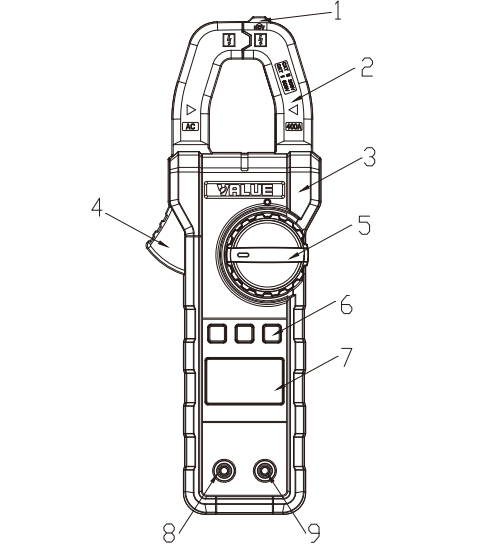
- 1) 将温度探头正极插入“测量信号输入端口”插孔,负极插入“COM”插孔。
- 2) 将量程开关置于“°C °F”档位,此时LCD显示OL,短路表笔则显示室温。
- 3) 将温度探头贴紧被测物表面,数秒后从LCD显示器上直接读取被测物表面温度值。
- 4) 按SELECT键可以选择华氏温度值与摄氏温度值之间切换。

### 注意

- 仪表所处环境温度不得超出18~28°C范围之外,否则会造成测量误差。
- 温度探头的正负极应正确连接于仪,不要测量非绝缘带电物体,避免仪表测出错误读数。
- 不要输入高于30V以上的交直流电压,以避免伤及人身安全。

#### 8. 非接触交流电压感测NCV(见图4)

当电场>100V AC 50Hz/60Hz,钳头部位的NCV感测端点接近(约≤15mm)蜂鸣声响,并显“N”横段,蜂鸣器发出滴响声,同时红色LED也闪烁;随着测量电场的强弱,蜂鸣器、红色LED会同步改变发声与发光闪烁的频率,电场强度越大,蜂鸣器发声频率和红色LED发光闪烁频率越高。16mm~80mm可发声或不发声;>80mm感测不能发声。



图4

### 注意

- 应采用钳头部位的NCV感测端点接近被测电场,不然影响测量灵敏度。
- 当被测电场>100V AC以上电压时,应注意观察所测电场的导体是否绝缘,以避免伤及人身安全。

### 七、LCD显示器说明(图2)

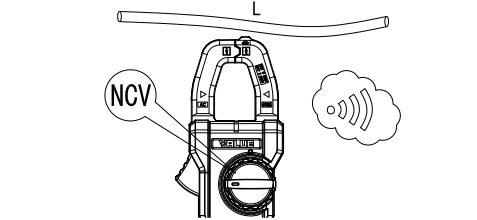

图2

### NMC-1/VMC-1 LCD显示屏

1	AUTO	自动量程提示符
2	MAX MIN	最大值/最小值测量提示符
3	REL ONOFF FVA	单位提示符
4	NCV	非接触交流电压感测提示符
5	°C °F	温度单位提示符
6	△	相对值提示符
7	⇄	二极管提示符
8	🔊	电路通断测量提示符
9	🔊	自动关机功能提示符
10	AC	交流信号提示符
11	□	负号
12	DC	直流信号提示符
13	🔋	电池低电量提示符
14	📄	数据保持提示符
15	⚡	高压提示符

### 八、按键功能说明

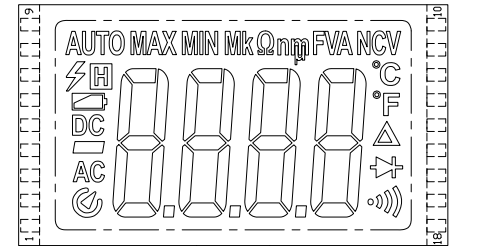
1. **SELECT/REL键**  
 a) 在复合功能量程档位上,按下SELECT/REL键可以在相应功能量程之间切换。  
 b) 在电容档位上,按下SELECT/REL进入相对值测量模式。
2. **HOLD/BACKLIGHT键**  
 a) 短按一次,进入读数保持测量模式,再按一次,退出读数保持测量模式。  
 b) 长按此键,打开背光,15秒内如再长按就会关闭背光,如不再长按,15秒后自动关闭背光。
3. **MAX/MIN键**  
 按一次进LCD会显示“MAX”符号,进入最大值测量模式,接着按一次,LCD显示“MIN”符号,进入最小值测量模式,如此循环。长按此键退出最大值/最小值测量。仅在交流/直流电压、交流电流、电阻、温度测量时有效。

### 9. 其他功能

- 1) 自动关机:在测量过程中旋钮开关约在15分钟内均无拨动时,仪表会“自动关机”以节能。在自动关机状态下点击任何按键,仪表会“自动唤醒”或将旋钮开关旋至OFF后重新开机。
- 2) 关机状态按住SELECT键后再上电开机,自动关机功能被取消。关机后重开则回复自动关机功能。
- 3) 蜂鸣器:按任何按键或转动功能开关时,如果该功能按键有效,蜂鸣器会发“Beep”一声(约0.25秒)。在测量电压或电流时,蜂鸣器也会发出“Beep”持续的间歌声,以示超量程警告,如下功能状态:
  - a. 交直流电压测量>约600V
  - b. 交/直流电流测量>400A时
  - 4) 低压检测:供电时检测内部VDD,当低于2.5V时,LCD显示“☹”电池欠压符号。

### 十一、保养和维护(见图5)

#### 警告

在打开底盖前为避免电击,请移开测试表笔。

1. 当仪表不使用时,应尽量将开关置于OFF档位,避免电池能量持续消耗。
2. 一般维护
  - a. 本仪表的维修与服务必须由有资格的专业维修人员或指定的维修部门完成。
  - b. 定期性使用干布去清洁外壳,但不得使用含有研磨剂或溶剂成份的清洁剂。
  3. 电池安装或更换  
 本产品的电源为2节AAA 1.5V电池,请按下列顺序安装或更换电池:
    - a. 本产品关机,请移开位于输入端之测试表笔。
    - b. 将本产品面板朝下,并旋开电池盒螺丝,拔出电池盖,取出电池,按照极性指示安装新电池。
    - c. 请使用同一型号的电池,不要安装不适当的电池。
    - d. 安装新的电池后,装上电池盖,并锁上螺丝即可。



图5

### 九、技术指标

**准确度:** ±(%读数+字数),校准期为一年;  
**环境温度湿度:** 23°C±5°C; ≤80%RH;  
**温度系数:** 准确度温度条件18°C至28°C,环境温度波动范围稳定在±1°C内。当温度<18°C或>28°C时,附加温度系数误差0.1×(指定准确度)/°C

量程	分辨率	准确度	过载保护
4.000A	0.001A	±(4%+20)	400A
40.00A	0.01A	±(3%+20)	
400.0A	0.1A	±(2.0%+10)	

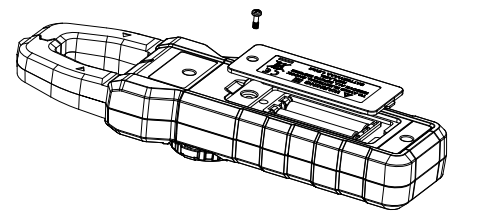
- 频率响应: 50Hz~60Hz;
- 4A量程开路允许有<5个字剩余额数
- 准确度保证范围: 5~100%量程;

### (2)交流电压

量程	分辨率	准确度	过载保护
4.000A	0.001A	±(0.7%+5)	600V Vrms
40.00A	0.01A	±(0.5%+2)	
400.0A	0.1A	±(1.0%+3)	
600V	1V		

- 输入阻抗≥10MΩ;
- 频率响应: 40~400Hz;
- 准确度保证范围: 5~100%量程;

### (3)直流电压

量程	分辨率	准确度	过载保护
400.0mV	0.1mV	±(0.7%+3)	600V Vrms
4.000V	0.001V	±(0.5%+2)	
40.00V	0.01V		
400.0V	0.1V	±(0.7%+3)	
600V	1V		

- 输入阻抗≥10MΩ;
- mV量程短路允许有≤5个数字,其它量程短路归零;
- 准确度保证范围: 1~100%量程;

### (4)电阻

量程	分辨率	准确度	过载保护
400.0Ω	0.1Ω	±(1.0%+2)	600V Vrms
4.000kΩ	0.001kΩ		
40.00kΩ	0.01kΩ	±(0.8%+2)	
400.0kΩ	0.1kΩ		
4.000MΩ	0.001MΩ	±(2.5%+5)	
40.00MΩ	0.01MΩ		