

**Reverse bender(\*Reverse bender is sold separately)**

1. Lock reverse bend retaining block using **Screw A** onto tube bender, press appropriately sized Mandrel with engraved side facing down into the reverse bend retaining block.
2. Lock crossbar onto reverse bend retaining block, then insert it into the ejector pin and lock it with **Screw B**.
3. Select desired notch size on tube size selector facing toward mandrel, put copper tube into size notch on both side, then start to reverse bend.

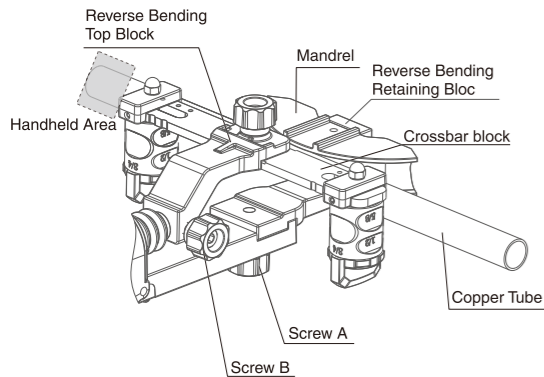

Fig. 8

**Charging**

1. Press down battery release tabs to remove battery.

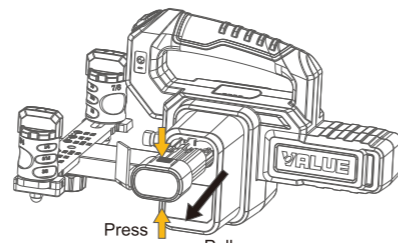

Fig. 9

2. Insert battery into the charger notch.

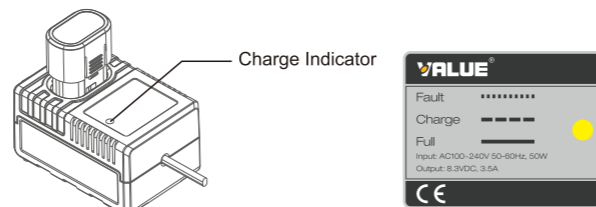

Fig. 10

**Troubleshooting**

**1. Electrical Failures**

Problem	Possible Cause	Solution
Work indicator one flash one off	Short circuit	Contact the manufacturer or dealer to repair
Work indicator two flash one off	ID detection failure	Check the battery or ID pin position
Work indicator three flash one off	Battery temperature protection	Wait for the battery to cool down or heat up
Work indicator four flash one off	Overcurrent protection	Reboot
Work indicator five flash one off	Motor temperature protection	Waiting for the motor to cool down
Work indicator six flash one off	Limit switch protection	Contact the manufacturer or dealer to repair
Charger indicator light flashes rapidly	Battery or charger failure	Contact the manufacturer or dealer to repair

Table 2

**2. Other Failures**

Problem	Possible Cause	Solution
Bender does not run or stops while operating when power switch and operation button is pressed	Low battery power	Charge
	Line or motor failure	Contact the manufacturer or dealer to repair
Copper tube deformation, fracture, poor angle	The selected tubing size selector notch does not match the copper tube	Select a suitable tubing size selector notch
	The selected mandrel does not match the copper tube	Select a suitable mandrel
	The selected gear on the crossbar does not match the copper tube	Follow the instructions on the crossbar to select the appropriate gear
	Tubing size selector is not locked	Lock the tubing size selector
	The bent copper tube is hard copper tube	Use the tool for FRESH SOFT COPPER tubing.

Table 3



**VALUE Mechanical & Electrical Products CO., LTD**

Add: No. 5 Third Street, East Industrial Park, Wenling, Zhejiang, China

Tel:+86-576-86191959

Fax:+86-576-86191957

Email:value@worldvalue.cn

www.worldvalue.cn

Making Your Job More Enjoyable

**VTB-22L**  
Power Tube Bender  
User Manual



### Safety Guide

**Warning:** To avoid injury, please read this instruction manual carefully before use.

1. Keep work area as clean as possible to avoid slips, falls or other injury while using tool.
2. Do not operate this or any other tool while under the influence of medications, drugs, or alcohol.
3. Keep this and all other power tools away from minors and any other untrained individuals.
4. Do not attempt to operate this tool with bending tool components from other manufacturers. Use the OEM parts included in the kit to avoid injury, tool destruction and a void warranty.
5. Keep all body parts, appendages, or objects away from moving parts during operation.
6. Product warranty is void if any changes, modifications, or customizations of the tool have taken place.
7. Batteries must be left intact and sealed; in addition to a void warranty, opening lithium-ion batteries may result in severe injury. Dispose of and handle batteries in accordance with local environmental regulations.
8. For troubleshooting faults or technical issues, please refer to table 2 and table 3.

### VTB-22L Parts Diagram



Fig. 1

### Technical parameters

Model	VTB-22L
Tubing OD	1/4"(6mm), 5/16"(8mm), 3/8"(10mm), 1/2"(12mm), 5/8"(16mm), 3/4"(19mm), 7/8"(22mm)
Dimension	325×250×180 mm
Weight	5.9 kg

#### Battery pack

Battery	7.2V 2Ah 14.4Wh
Quick Charge	35 minutes
Ambient Temperature	5°C-40°C

#### Charger

Power Supply	AC 100-240V (50/60Hz) 50W
Output Voltage	8.3 V
Output Current	3.5 A
Ambient Temperature	5°C-40°C

Table 1

### Tube bender operating instructions

#### 1. Preparation

Always use the tool for **FRESH SOFT COPPER** tubing. Hard copper tubing will result in failure. Deformed (squished, kinked, oval, etc.), oxidized copper tubing or non-copper tubing will result in failure.

#### 2. Crossbar installation

Tighten crossbar screw to lock the crossbar on the tool.

#### 3. Battery installation

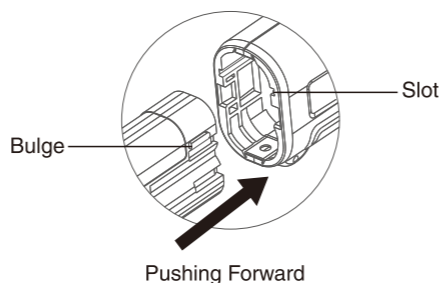

Fig. 3

### Tube bender operating instructions

#### 4. Use of tube bender

4.1 Set up tubing size selector, then lock; Loosen locking nut on tubing size selector, slide it to the desired position: as shown below (①, ②, ③), tighten locking nut on the tubing positioner.

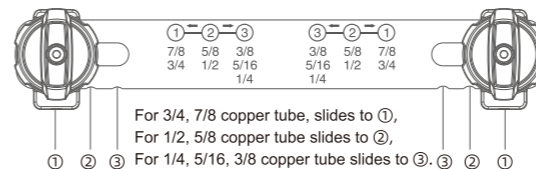

Fig. 4

#### 4.2 Align size notch to copper tube

Turn size selection wheel, let the right size notch facing towards tool body, align tube onto the notches on both sides. **WRONG SIZE NOTCH WILL RESULT IN FAILED BEND, OR FUTHER DAMAGE THE TOOL ITSELF.**

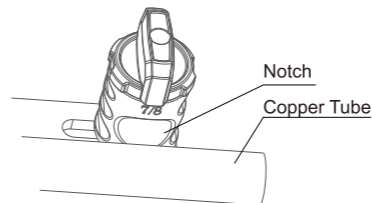

Fig. 5

#### 4.3 Mandrel installation

Choose the correct size mandrel. Allow angle marks facing up. Attach mandrel to the top of the Pushing Head by simply pressing down until you feel the spring latch engages. To disassemble, push mandrel out using two hands, each on one side of the mandrel.

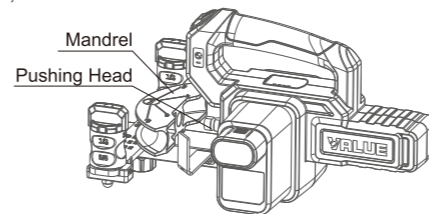

Fig. 6

### Tube bender operating instructions

#### 4.4 Bend tube

Press power switch to turn the tool on. When the indicator light is green, hold the copper tube with one hand, put it into tube notch so it's well fit. Use the other hand to push the control button forward.

**Warning:** Avoid physical contact with moving parts of the tool when bending.

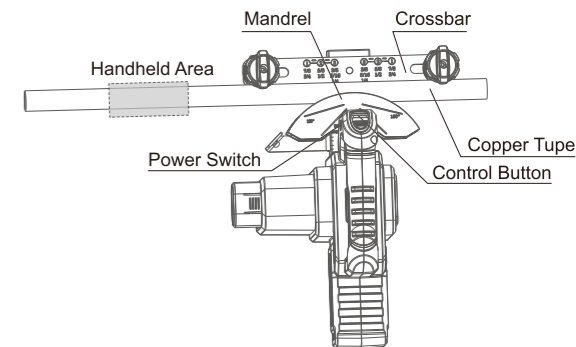

Fig. 7

The copper tube will be bent to 90° when bender stops automatically. To bend other angles, refer to angle marks on mandrel.

#### 5. Release tube

Pull control button backward, mandrel will back up. Tube will be pushed out automatically.

#### 6. Standby

- 6.1 After bending, tap Power Switch, turn tool to standby mode.
- 6.2 Tool will automatically enter power saving mode, indicator light will go out if no operation in 5 minutes.