

Making Your Job More Enjoyable
Recovery Unit User Manual

VRR24M-C



VALUE Mechanical & Electrical Products CO., LTD

Add: No. 5, 3rd. Street, East Industrial Park, Wenling, Zhejiang, China

Tel: +86-576-86191959

Email: value@worldvalue.cn www.worldvalue.cn

TABLE OF CONTENT

General Safety.....	1
Operation Manual.....	3
Specification.....	5
Introduction of Operation Panel.....	6
Parts Diagram.....	7
Wiring Diagram.....	8
Operating Instruction	
1). Refrigerant Hoses Exhaust	9
2). Recovery Method.....	10
3). Self-purge Method.....	11
4). Liquid Push/Pull Method.....	12
Trouble Shooting	13

GENERAL SAFETY

Use information

- In order to prolong the usage of the recovery unit, please read the manual carefully before using, which can help you to fully understand the safety, specification as well as operating procedure of the recovery unit.
- Please check the product received is same as you ordered.
Please check the product if there is any damage during transportation.
Contact with local distributor if the above problem is found.
- Please read the manual carefully and use the unit according to the product operating procedures.

Safety indication

Warning

This mark indicates procedures that must be strictly observed to prevent hazards to people.

Notice

This mark indicates procedures must be strictly observed to prevent damage or destruction of the unit.

Matters needing attention

Warning

Only a qualified technician can operate this recovery unit.

Before starting the equipment, make sure that it is well grounded.

While using electrical wire, the wire must be well connected and grounded.

Only a qualified electrician can do the wire connection according to the technical standard and circuit diagram.

The power must be cut off and no display in LCD before inspecting or repairing.

If the original power supply cord is damaged, choose carefully for the replacing one, or you may directly buy from distributor.

Please take power supply and the capacity of your ammeter and electrical wire.

GENERAL SAFETY

Only authorized refillable refrigerant tanks can be used. It requires the use of recovery tanks with a minimum working pressure of 45 bar(652.6 psi). Do not overfill the recovery tank, maximum at 80% capacity to make sure that there is enough space for liquid expansion. Overfilling of the tank may cause a violent explosion.

Always wear safety goggles and protective gloves while working with refrigerants to protect your skin and eye from hurting by refrigerant gases or liquid.

Do not use this equipment near flammable liquid or gasoline.

An electric scale is needed to prevent overfilling.

Be sure that the place where you are working is thoroughly ventilated.

Notice

Be sure the unit is working under the right power supply.

When using an extension cord it should be minimum 14 AWG and no longer than 25 feet, otherwise it may cause the voltage drop and damage the compressor.

The input pressure of the unit should not exceed 26bar (377.0psi) .

The unit need to be laid in horizontally, otherwise it will lead to unexpected vibration, noise or even abrasion.

Do not expose the equipment to sun or rain.

The ventilation opening of the unit must not be blocked.

If the overload protector pops, reposition it after 5 minutes.

When doing self purging operation, the knob must be turned slowly to "PURGE" to ensure the inlet pressure is less than 5 bar(72.5 psi).

If fluid hammer happens in the recovery, please turn the knob slowly to "SLOW " position and do not let reading pressure drop to zero.

To ensure the stable running of the machine, close the knob to the close position when the outlet pressure over 27 bar (391.6 psi), to decreasing the inlet pressure (not reach 0) .This action is to make the outlet pressure stable or decreasing, the controled pressure less than 30bar(435.1 psi).

The equipment is intended for serving air-conditioning and refrigeration systems containing more than 200 lbs of high-pressure refrigerant.

The tank and hose used must be complied with the local regulations.

OPERATION MANUAL

1. Do not mix different refrigerants together in one tank, otherwise they could not be separated or used.
2. Before recovering the refrigerant, the tank should achieve the vacuum level: $\sim 29.6\text{inHg}$, for purge non-condensable gases. Each tank was full of nitrogen when it was manufactured in the factory, thus the nitrogen should be evacuated before first use.
3. The knob should be at "Close" Position before operation. All the valves must be closed, the input and output fittings should be covered with protective caps when the unit is not in operation. The air moisture is harmful to the recovery result and will shorten the life span of the unit.
4. A filter drier should always be used and should be replaced regularly. And each type of refrigerant must have its own filter. For the sake of ensuring the normal operation of the unit, please use the filter specified by our company. High quality filter drier will bring high quality services.
5. Special-caution is needed when recovering from system, and two dry filters are needed.
6. The unit has an Internal High Pressure protector. If the pressure inside the system is above rated shut-off pressure (see specification) , compressor will automatically shut off and the HP cutoff shows. To restart the compressor, please lower the internal pressure (Output gauge indicates lower than 30 bar/435.0 PSI), after the HP cutoff blinks, then Press the "START" button to restart the compressor. When high pressure protection initiates, please find out the cause and deal with it before restarting the unit.
 - ① The input valve of the refrigerant tank is closed——opening the valve will help solve the problem.
 - ② The connecting hose between the recovery unit and refrigerant tank is stuck——close all the valves and replace the connecting hose.
 - ③ The temperature of the refrigerant tank is too high, pressure is too high causing high pressure——make the tank cool.

SPECIFICATION

VRR24M-C		
Refrigerants	Category III: R12, R134a, R401C, R406A, R500, 1234YF	
	Category IV: R22, R401A, R401B, R402B, R407C, R407D, R408A, R409A, R502, R509	
	Category V: R402A, R404A, R407A, R407B, R410A, R507, R32	
Power	220V-230V AC, 50/60Hz	115V AC, 60Hz
Maximal Current Draw	6.5 A	12A
Motor	Brushless Motor 1 HP	
Motor Speed	3000 RPM	
Compressor	Oil-less, Air-cooled, Piston	
High Pressure Protector	38.5bar/3850kPa(558psi)	
Operating Temperature	32~104°F	
Dimensions	14.5×9.9×11.7 inch	
Net Weight	25 lbs	

NRDD

Refrigerants	R134a	R22	R410A
Liquid	2.6 kg/min	2.9 kg/min	3.9 kg/min
Push/Pull	7.5 kg/min	8.5 kg/min	9.5 kg/min

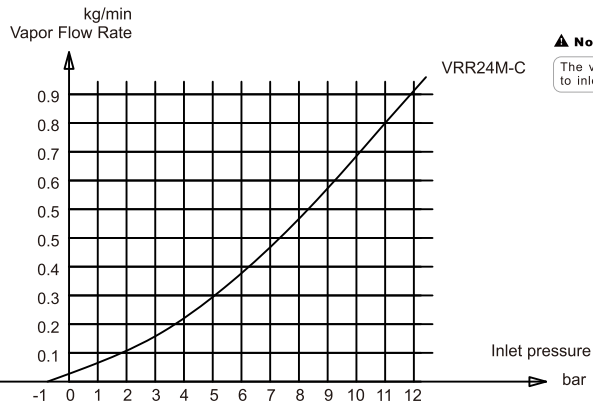

▲ Notice
The vapor flow rate is proportioned to inlet pressure.

INTRODUCTION OF OPERATION PANEL

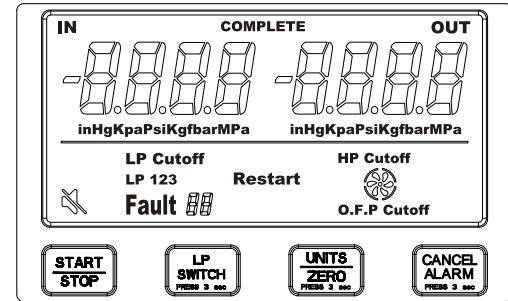

Start/Stop: Starts and Stops recovery unit

LP Switch: Hold for 3 seconds to switch between LP1, LP2, LP3

Units/Zero: Press to change units to InHg, Kpa, Psi, Kg/f, Bar, Mpa.

Hold for 3 seconds to zero out readings

Cancel Alarm: Hold for 3 Seconds to mute recovery unit

LP1: (Auto shutoff with manual restart)

If the inlet pressure is lower than -20inHg for 20 seconds, the unit will shut down. "LP Cutoff" will be displayed.

When $LP \geq 0$ inHg you must press START to restart the recovery unit

LP2: (Auto Shutoff with automatic restart)

If the inlet pressure is lower than -20 inHg for 20 seconds the unit will shutdown "LP Cutoff" is displayed.

When $LP \geq 0$ inHg the unit will restart automatically

LP3: (Continuous Run)

The recovery unit will run continuously, no matter what the level the input pressure is (LP)

O.F.P Cutoff: Will Light up when the recovery cylinder is 80% filled, or if the OFP cable is shorted. The machine will stop running

LP Cutoff: Will light up when low pressure switch is activated for more than 20 seconds below -20 inHg

HP Cutoff: Will Light up when high pressure switch is activated above 560 Psi

INTRODUCTION OF OPERATION PANEL

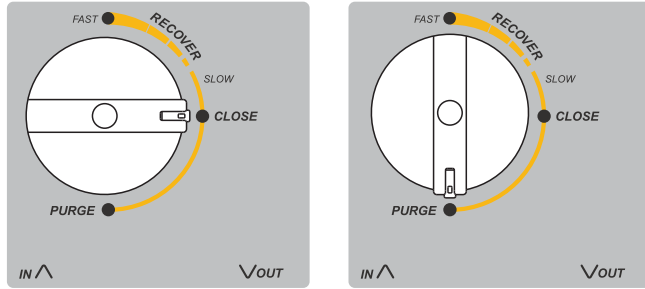

- Close: Inlet valve is closed
- Recover: Input valve is partially opened
- Fast: Input valve is fully opened
- Purge: Input closed, and output is opened to allow the unit to remove most of the refrigerant inside the recovery machine

Fault: Error Codes

- E1: The pressure sensor is disconnected
- Fault 2: Input voltage is too low
- Fault 3: High input voltage
- Fault 4: Overcurrent protection
- Fault 5: Temperature Sensor Breaker
- Fault 6: Temperature sensor Short Circuit
- Fault 7: Temperature protector breaker.

Mute: Audible alerts and beeps are turned off

Fan: This icon rotates while the machine is running. When the machine stops, the icon is still

Restart: It will flash after an error has occurred and settled. Pressing START will resume activity.

PARTS DIAGRAM

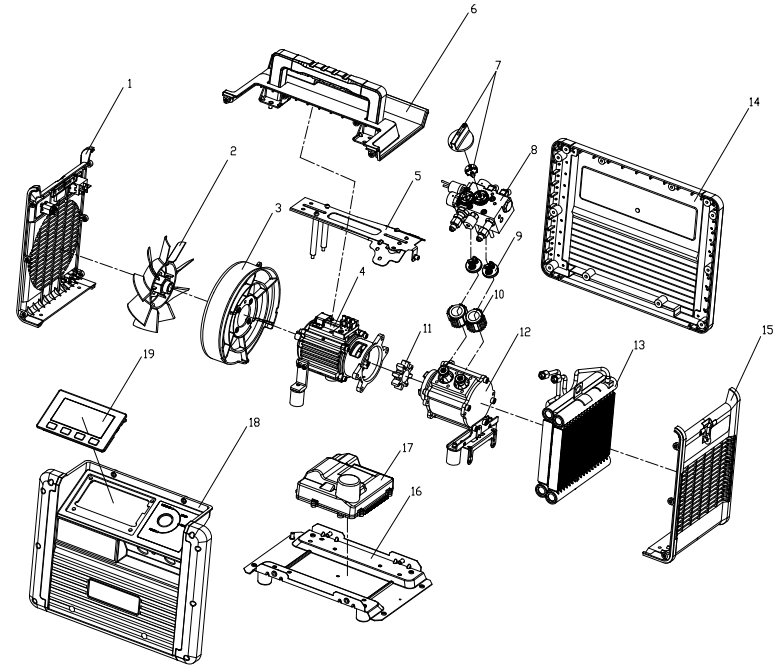

NO.	Parts name	NO.	Parts name
1	Left Side Plate	12	Compressor
2	Fan	13	Condenser
3	Wind Guide Cover	14	Rear Plate
4	Motor	15	Right Side Plate
5	Support Assy	16	Base
6	Top Plate	17	Motor Control
7	Knob	18	Front Side Plate
8	Control Assy	19	Gauge
9	Valve Assy		
10	Cylinder		
11	Coupling		

WIRING DIAGRAM

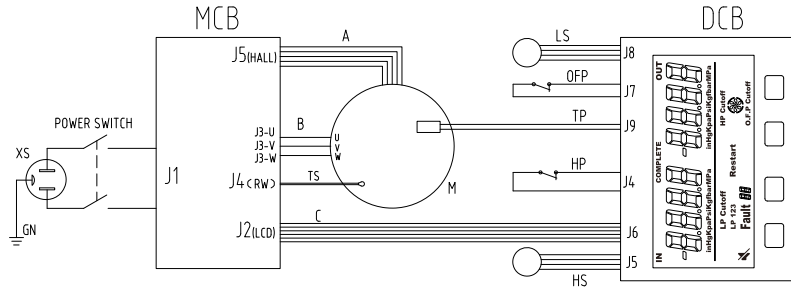

Graphics Code	ITEM
HS	High pressure sensor
M	Motor
MCB	Motor control board
XS	Socket
DCB	Digital gauge control board
LS	Low pressure sensor
OFP	Over filling protector
TP	Temperature protector
HP	High pressure switch
TS	Temperature sensor

OPERATING INSTRUCTION

1). Refrigerant hoses exhaust

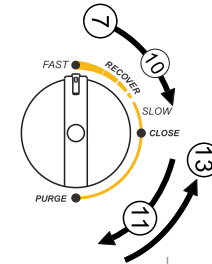
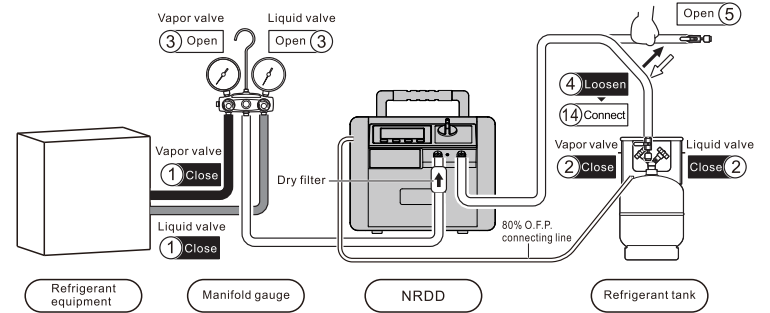

Ready for operation

Connect the hoses correctly and firmly.

(Please refer to the connection diagram)

1. Confirm the vapor valve and liquid valve of AC system are in close position.
2. Confirm the vapor valve and liquid valve of recovery tank are in close position.
3. Open the vapor and liquid valves of manifold gauge.
4. Loosen the connecting pipes of refrigerant tank.
5. Open the check valve of pipes.

Start operation

6. Plug in the machine, turn on the power, and the LCD shows pressures.
7. Turn the knob to "Recover".
8. Press the "START" button to start machine, it begins to purge inner air of the hose.

9. Observe the reading of the low pressure gauge when it reaches to -20inHg, after 20 seconds, LP cutoff turns on and the machine stops work .
10. Turn the knob to "Close", LP cutoff blinks, press the power button and start machine.
11. Turn the knob slowly to "Purge" and start self purging.
12. Observe the reading of the low pressure gauge when it reaches to -20inHg for the second time, after 20 seconds, LP cutoff turns on and the machine stops work .

Finish operation

13. Turn the knob to "Close" and stop self purging.
14. Connect the refrigerant hose to the tank.

OPERATING INSTRUCTION

2). Recovery mode

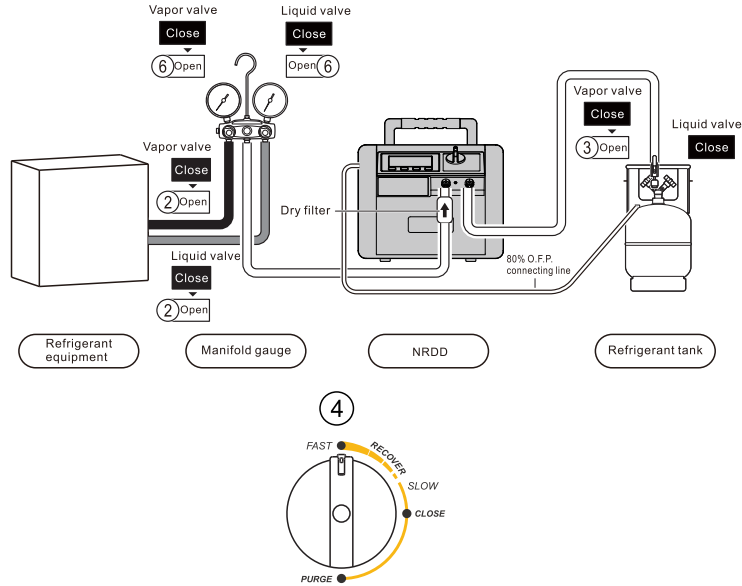

Ready for operation

- Connect the hoses correctly and firmly.
(Please refer to the connection diagram)
- Make sure all valves are closed.
- 1. Switch off the power of refrigerant equipment.
- 2. Open the vapor and liquid valves of refrigerant equipment.
- 3. Open the vapor valve of the refrigerant tank.

Start operation

- 4. Turn the knob to "Recover".
- 5. Press the "START" button to start machine.
- 6. a. If recover liquid refrigerant, please open the liquid valve of the manifold gauge.
b. If recover vapor refrigerant, please open the vapor valve of the manifold gauge.

- 7. The recovery mode will be finished when machine runs to certain vacuum degree or automatic close of low pressure protection..
- Do not turn off the power after recovery finished and directly run self purging mode.

Notice

- ① If fluid hammer happens in the recovery, please turn the knob to "Slow" position slowly, Then the reading of low pressure gauge drops until fluid hammer stops; but do not let reading pressure drop to zero, otherwise inlet port is not pumping once at zero pressure.
- ② If it is difficult to start, turn to "CLOSE" when liquid, turn to "PURGE" when vapor, then press "START" to restart the machine, and turn to the required position.

OPERATING INSTRUCTION

3). Self-purge mode

Notice

The unit must be purged after each use;
Liquid refrigerant remained may expand and damage the components and pollute the environment.

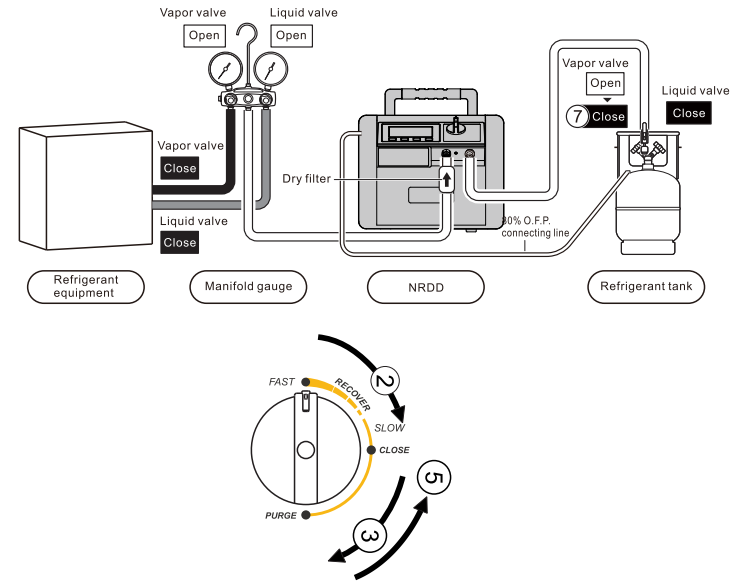

Start operation

- 1. The machine stops automatically after recovery finished with LP cutoff on.
- 2. Turn the knob to "Close" and the LP cutoff blinks, press "START" button to start the machine.
- 3. Turn the knob to "Purge" and start self purging.
- 4. The self purging mode will be finished when machine runs to certain vacuum degree.

Finish operation

- 5. Turn the knob to "Close".
- 6. Turn off the power switch. Disconnect power cord.
- 7. Close the check valve which connected to exhaust.
- 8. Close the vapor valve of the tank.
- 9. Disconnect all hoses.

OPERATING INSTRUCTION

4). Liquid push/pull mode

▲ Notice

An electric scale is needed to monitor the recover process to prevent overfilling.

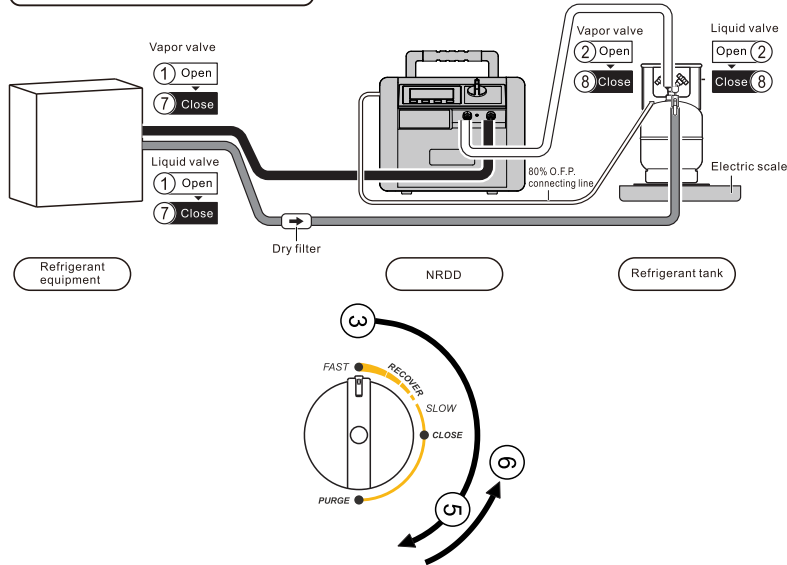

Ready for operation

- Connect the hoses correctly and firmly.
(Please refer to the connection diagram)
- Make sure all valves are closed.

Start operation

1. Open the vapor valve, liquid valve of the HVAC system.
2. Open the vapor valve, liquid valve of the tank.
3. Turn the knob to "Recover".
4. Press "START" button to start machine, then it starts liquid push/pull mode.

If the reading on the scale keeps the same or changes slowly, it means liquid in HVAC system has been recovered and vapor recovery mode can be underway.

5. Turn the knob slowly to "Purge" and start self purging mode for the liquid.
6. Turn the knob to "Close".
7. Close the vapor valve, liquid valve of the HVAC system.
8. Close the vapor valve, liquid valve of the tank.
9. Reconnect the hoses and start recovery mode for the vapor.

Finish operation

TROUBLE SHOOTING

PROBLEM	CAUSE	SOLUTION
LCD does not work after power is on	<ol style="list-style-type: none"> 1. Power cord is damaged. 2. Inner connection is loose. 3. Connect to J6 is damaged. 4. Malfunction of circuit board. 	<ol style="list-style-type: none"> 1. Replace cord. 2. Check the connection. 3. Replace the connect. 4. Replace MCB or DCN circuit board. Contact VALUE techsupport.
Machine does not run after pressing START	<ol style="list-style-type: none"> 1. HP Cutoff, or OFP Cutoff works (screen shows.) 2. Fault 2 or Fault 3 3. Fault 4, too much start-overload 4. Fault 5 5. Fault 6 6. Fault 7 7. Button is damaged. 8. Circuit board is damaged. 	<ol style="list-style-type: none"> 1. Check if the connection between HP or OFP to DCB is good. 2. Adjust to correct voltage. 3. Turn to "CLOSE" when liquid, turn to "PURGE" when vapor, then press "START" to restart the machine, and turn to the required position. 4. Check if the connection between TS and MCB is good. If good, contact VALUE techsupport. 5. Check if TS connection is damaged. If not, contact NAVAC techsupport. 6. Check if the connection between TP and MCB is good. If good, contact NAVAC techsupport. 7. Replace digital gauge. 8. Replace circuit board.
Machine stops after running a period of time	<ol style="list-style-type: none"> 1. Misoperation causes HP Cutoff. 2. Thermal protector is on and shows Fault 7. 3. Refrigerant is 80% in the tank, and O.F.P Cutoff shows. 4. Recovery work is finished. LP Cutoff shows. 	<ol style="list-style-type: none"> 1. Refer the clause 6 of OPERATION MANUAL. 2. When Fault 7 and Restart flash, press START. 3. Replace the tank. When O.F.P Cutoff and Restart flash, press START. 4. Could restart for other work.
E1 shows at LP or HP	Pressure sensor is not connected well or is short circuit.	Check if the connection between LS or HS to DCB is good. If good, replace pressure sensor.
Slow recovery rate	<ol style="list-style-type: none"> 1. The pressure of the refrigerant tank is too high. 2. Piston ring of compressor is damaged. 	<ol style="list-style-type: none"> 1. Cooling the tank help decrease the pressure. 2. Contact VALUE techsupport.
Not evacuate	<ol style="list-style-type: none"> 1. Connection hose is loose. 2. Machine leaks. 	<ol style="list-style-type: none"> 1. Tighten the connection hoses. 2. Contact VALUE techsupport.