

Version: E  
No.: 1100037810



**Making Your Job More Enjoyable**

**VRDDF** Recovery Unit

ATEX-Certified\*

**A1 A2L A2 A3**

R290, R600a etc.



**VALUE Mechanical & Electrical Products CO., LTD**

Add: No. 5, 3rd. Street, East Industrial Park, Wenling, Zhejiang, China

Tel:+86-576-86191959

Fax:+86-576-86191957

Email: [value@worldvalue.cn](mailto:value@worldvalue.cn)

[www.worldvalue.cn](http://www.worldvalue.cn)

**VALUE** • Quality Assurance



## TABLE OF CONTENT

<b>Certifications</b> .....	01
<b>General Safety</b> .....	02
<b>Additional Safety Instruction</b> .....	04
<b>Operation Manual</b> .....	05
<b>Specification</b> .....	06
<b>Performance Data</b> .....	06
<b>Introduction of Operation Panel</b> .....	07
<b>Parts Diagram</b> .....	09
<b>Wiring Diagram</b> .....	10
<b>Operating Instruction</b>	
1). Refrigerant Hoses Exhaust .....	11
2). Recovery Mode .....	12
3). Self-purge Mode .....	13
4). Liquid Push/Pull Mode .....	14
<b>Trouble Shooting</b> .....	15

## CERTIFICATIONS

### Certified and tested according to:

EN IEC 60079-0:2018  
 EN IEC 60079-7:2015+A1:2018  
 EN 60079-11:2012  
 EN IEC 60079-15:2019  
 EN ISO 80079-36:2016  
 EN ISO 80079-37:2016

## CE II 3G Ex ec ic nC h IIA T4 Gc

CE	Denotes that this product complies with ATEX directives Certificate No. is CSANe 22ATEX1032X
	Specific marking for explosion protection
3	Zone 2
G	Gas
Ex	Denotes explosion protection
ec	Increased safety
ic	Intrinsic safety
nC	Sealed device
h	Constructional safety
IIA	Typical gas - R290, R600a etc.
T4	135°C
Gc	EPL - Equipment Protection Level

### Specific Conditions Of Use:

1. Provision shall be made external to the equipment that ensures that the circuits are limited to over voltage category II as defined in EN 60664-1.
2. In the final use, the OFP port shall comply with at least IP20.
3. Maximum recovery weight of refrigerant not exceed 80kg one time. After the working, the machine shall be stopped and ensured the refrigerant to be cooling.
4. Equipment shall not be installed in a location where the external conditions are conducive to the build-up of electrostatic charge on such surfaces. In addition, the equipment shall only be cleaned with a damp cloth.
5. Equipment shall be operated such that the supply cable is protected from mechanical damage. The cable shall not be subjected to tension or torque.

### Warning:

1. WARNING – DO NOT OPEN WHEN AN EXPLOSIVE ATMOSPHERE MAY BE PRESENT
2. WARNING – DO NOT CONNECT OR DISCONNECT WHEN ENERGIZED

## GENERAL SAFETY

### Use information

- In order to prolong the life cycle of the recovery unit, please read the manual carefully before using to fully understand the safety, specification as well as operating procedure of the recovery unit.
- Please check the product received is same as you ordered.
- Please check the product if there is any damage during transportation.
- Contact with local distributor if the above problem is found.
- Please read the manual carefully and use the unit according to the product operating procedures.

### Safety indication

#### Warning

This mark indicates procedures that must be strictly observed to prevent hazards to people.

#### Notice

This mark indicates procedures must be strictly observed to prevent damage or destruction of the unit.

### Matters needing attention

#### Warning

For recovering only HVAC/R refrigerants from sealed HVAC/R systems. Warranty VOIDED if used for any other purposes.

Only a qualified technician should operate this recovery unit.

Before starting the equipment, make sure that it is well grounded.

If using electrical extension cord, the cord must be in good condition and properly connected and grounded.

Only a qualified electrician can do the wire connection according to the technical standard and circuit diagram.

The power must be cut off and no display in LCD before inspecting or repairing.

If the original power supply cord is damaged, an OEM replacement may be ordered through your VALUE distributor.

Please check the capacity of your power supply, ammeter, electrical wires and circuit before use.

Only authorized refillable refrigerant tanks can be used. The setting of the pressure limiting device shall not be lower than 45 bar(653psi). Do not overfill the recovery tank, maximum at 80% capacity to make sure that there is enough space for liquid expansion. Overfilling of the tank may cause a violent explosion.

## GENERAL SAFETY

Always wear safety goggles and protective gloves while working with refrigerants to protect your skin and eye from hurting by refrigerant gases or liquid.

Do not use this equipment near flammable liquid or gasoline.

A digital scale is needed to prevent overfilling.

Be sure that the place where you are working is thoroughly ventilated.

### Before connecting, be sure to turn on the recovery unit to check:

1. If the fan is working properly (if there's air blowing out from the condenser side).
  2. Connect the check valve to the outlet port and close the check valve. Keep the inlet port open to atmosphere. Turn the knob to the "FAST" position and start the machine. The pressure on the outlet side should rise to 560Psi (38.6bar) within 65secs. After that, the high pressure switch protection switch is on, and the machine will automatically shut down.
  3. Leakage detection must be performed before extracting A2L, A2, and A3 to ensure that there is no obvious leakage. The leakage method is as follows:
    - 1) Use the ball valve to block the air outlet and keep the air inlet open to the atmosphere.
    - 2) Turn the knob to the "FAST" position, start the machine, and when the air outlet pressure rises to 30Bar (3MPa/435PSI), press "STOP", and then turn the knob to "PURGE" and observe the intake side pressure gauge value.
    - 3) After standing for 3 minutes, observe the reading of the intake side pressure gauge value again. If the pressure drops  $\leq 1$ bar (0.1MPa/14.5PSI), there is no obvious leakage, then normal operations can be performed.
- During use, please use the appropriate leak detector to monitor the leakage. If there is a leaky leak, please stop running immediately.

### Notice

Be sure the unit is working under the right power supply.

When using an extension cord it should be minimum 14 AWG and no longer than 25 feet, otherwise it may cause the voltage drop and damage the compressor.

The input pressure of the unit should not exceed 26bar (377.Opsi)

The unit need to be laid in horizontally, otherwise it will lead to unexpected vibration, noise or even abrasion.

Do not expose the equipment to sun or rain.

The ventilation opening of the unit must not be blocked.

If the overload protector pops, reposition it after 5 minutes.

When doing self purging operation, the knob must be turned slowly to "PURGE" to ensure the inlet pressure is less than 5 bar(72.5 psi).

If fluid hammer happens in the recovery, please turn the knob slowly to "SLOW" position and do not let reading pressure drop to zero.

When you select fast model to start work, please monitor output pressure, if the output pressure increase fast to 27bar(391.6 psi),please turn to slow mode slowly and monitor the outlet pressure not exceeding 35bar(507.6 psi).

The equipment is intended for serving air-conditioning and refrigeration systems containing less than 200 lbs of high-pressure refrigerant.

The tank and hose used must comply with the local regulations.

## ADDITIONAL SAFETY INSTRUCTION

### Additional Safety Instructions for refrigeration systems containing Flammable refrigerants.

Except for existing occupational hazard procedures or other regulations that may be required by local, state or federal agencies, the following are additional safety recommendations when servicing refrigeration equipment that contain Class A2L, A2 or A3 refrigerants.

The area of service should be marked as Temporary Hazardous Zone. This will be an area with a radius of 3m centered on refrigeration equipment being serviced and should have no smoking and other hazardous signs posted. Local supervisor should be notified of the zone's existence.

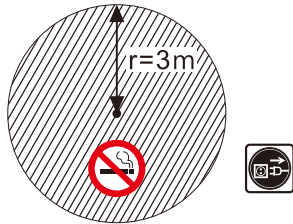

- Refrigeration equipment being serviced

Division (zone) 2

- Ensure the refrigeration equipment's power has been discontinued during maintenance work.
- When connecting service equipment (such as vacuum pumps, scales, recovery units) to a power source, the connection must be made outside the Temporary Hazardous Zone.
- Factory-equipped power cord of VRDDF is 3.2m, which can make sure the connection is made in the area free of ignitable concentrations. Do not change the power cord at will.

## OPERATION MANUAL

1. Do not mix different refrigerants together in one tank, otherwise they could not be separated or used.
  2. Before recovering the refrigerant, the tank should achieve the vacuum level: -29.6inHg, for purge non-condensable gases. Each tank was full of nitrogen when it was manufactured in the factory, thus the nitrogen should be evacuated before first use.
  3. The knob should be in the "Close" Position before operation. All the valves must be closed, the input and output fittings should be covered with protective caps when the unit is not in operation. The air/ moisture is harmful to the recovery result and will shorten the life span of the unit.
  4. A filter drier should always be used and should be replaced regularly. And each type of refrigerant must have its own filter. For the sake of ensuring the normal operation of the unit, please use highquality filter drier specified by our company. A high quality filter drier will help protect machine.
  5. Special-caution is needed when recovering from system, and two dry filters are needed.
  6. The unit has an Internal High Pressure protector. If the pressure inside the system is above rated shut-off pressure (see specification) , compressor will automatically shut off and the HP cutoff shows. To restart the compressor, please lower the internal pressure (Output gauge indicates lower than 35 bar/507.6 PSI), after the HP cutoff blinks, then Press the "START" button to restart the compressor.
- When high pressure protection initiates, please determine the cause and deal with it before restarting the unit.
- ① The input valve of the refrigerant tank is closed- opening the valve will help solve the problem.
  - ② The connecting hose between the recovery unit and refrigerant tank is plugged - close all the valves and replace the connecting hose.
  - ③ The temperature of the refrigerant tank is too high, causing high pressure- cool the tank down.
7. The recovery unit is fitted with an O.F.P. socket, short connector and connecting cable for connection to cylinders with full fluid protection output connector, which needs to be plugged in for operation when the O.F.P. connecting cable is not plugged in.
  8. For the A3 refrigerant, when the pressure on the intake side reaches 0 bar, please stop running immediately.

## SPECIFICATION

VRDDF	
Refrigerants	Category III: R12, R134a, R401C, R500, R1234YF, R600a Category IV: R22, R401A, R401B, R402B, R407C, R407D, R408A, R409A, R411A, R411B, R412A, R502, R509, R290 Category V: R32, R402A, R404A, R407A, R407B, R410A, R507
Power	220V-240V AC, 50/60Hz
Motor	Brushless Motor, 750W
Motor speed	3000 RPM
Current	6.5A
Compressor	Oil-less, Air-cooled, Piston
High Pressure Protector	38.5bar/3850kpa(558psi)
Operating Temperature	0~40°C
Dimensions	370x250x297mm
Net Weight	11.5kg

A3 Refrigerants							
Applicable	R50	R170	R290	R600	R600a	R601	R601a
	R1270	R430A	R431A	R433A	R433B	R433C	R436A
	R436B	R441a	R443A	R511A			
Not applicable	R702	RE170	R1150	R429A	R432A	R435A	R510A

## PERFORMANCE DATA

VRDDF UL Verified Test Results (SA45503)				
Refrigerant	R22	R134a	R407C	R410A
Push/Pull Recovery (kg/min)	7.73	5.81	7.75	8.35
Liquid Recovery (kg/min)	5.04	3.56	5.56	6.55
Vapor Recovery (kg/min)	0.29	0.26	0.28	0.34
Final Recovery Vacuum (kPa)	50.8	50.8	50.8	50.8
Residual Trapped Refrigerant (kg)	0.007	0.006	0.006	0.005
High Temp (104°F) (kg/min)	0.34	/	/	/

## INTRODUCTION OF OPERATION PANEL

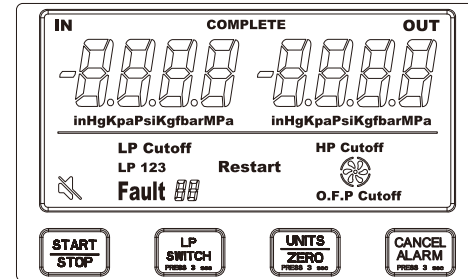

- Start/Stop: Starts and Stops recovery unit.
  - LP Switch: Hold for 3 seconds to switch between LP1, LP2, Lp3.
  - Units/Zero: Press to change units to InHg, Kpa, Psi, Kg/f, Bar, Mpa. Hold for 3 seconds to zero out readings.
  - Cancel Alarm: Hold for 3 seconds to mute recovery unit.
  - **LP1: (Auto shutoff with manual restart)**  
if the inlet pressure is lower than -20inHg for 20 seconds, the unit will shut down. "LP Cutoff" will be displayed.  
When LP ≥ 0 inHg you must press START to restart the recovery unit
  - **LP2: (Auto shutoff with automatic restart)**  
if the inlet pressure is lower than -20inHg for 20 seconds, the unit will shut down. "LP Cutoff" is displayed.  
When LP ≥ 0 inHg the unit will restart automatically.
  - **LP3: (Continuous Run)**  
The recovery unit will run continuously, no matter what the level the input pressure is (LP)
  - O.F.P Cutoff: Will light up when the recovery cylinder is 80% filled, or if the OFP cable is opened. The machine will stop running.
  - LP Cutoff: will light up when low pressure switch is activated for more than 20 seconds below -20 inHg.
  - HP Cutoff: Will light up when high pressure switch is activated above 560 Psi.
- Restart: It will flash after an error has occurred and settled. Pressing "START" will resume activity.
- Fault: Error Codes
- E1: The pressure sensor is disconnected
  - Fault 2: Input voltage is too low
  - Fault 3: High input voltage
  - Fault 4: Overcurrent protection
  - Fault 7: Temperature protector open
  - Fault 8: Motor stalling

Mute: Audible alerts and beeps are turned off.

Fan: This icon rotates while the machine is running. When the machine stops, the icon stops rotating.

## INTRODUCTION OF OPERATION PANEL

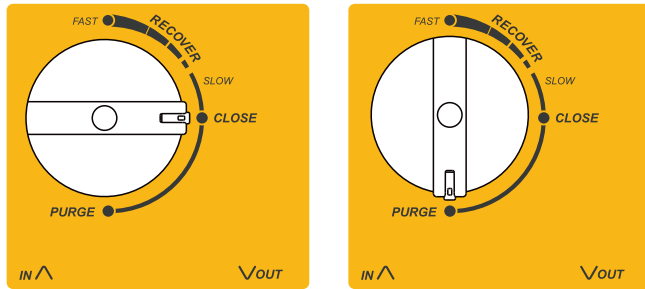

Close: Inlet valve is closed

Recover: Input valve is partially opened

Fast: Input valve is fully opened

Purge: Input closed, and output is opened to allow the unit to remove most of the refrigerant inside the recovery machine

## INTRODUCTION TO THE WORKING PRINCIPLE OF PISTON COMPRESSOR

- When the crankshaft of the compressor rotates, the piston reciprocates through the transmission of the connecting rod, and the working volume formed by the inner wall of the cylinder, the cylinder head and the top surface of the piston will periodically change.
- When the piston starts to move from the cylinder head, the working volume in the cylinder gradually increases, the pressure in the volume decreases, the intake valve opens, and the exhaust valve closes. At the same time, the gas enters the cylinder along the intake pipe until the working volume reaches the maximum.
- When the piston moves in the reverse direction, the working volume in the cylinder decreases, the gas pressure rises, and the intake valve closes. When the pressure in the cylinder reaches and exceeds the exhaust pressure, the exhaust valve opens and the gas is discharged from the cylinder until the piston moves to the limit position. Such reciprocating movement realizes gas extraction.
- The crankshaft of the piston compressor rotates once, the piston reciprocates once, and the process of air intake, compression, and exhaust is realized in the cylinder, that is, a working cycle is completed.

## PARTS DIAGRAM

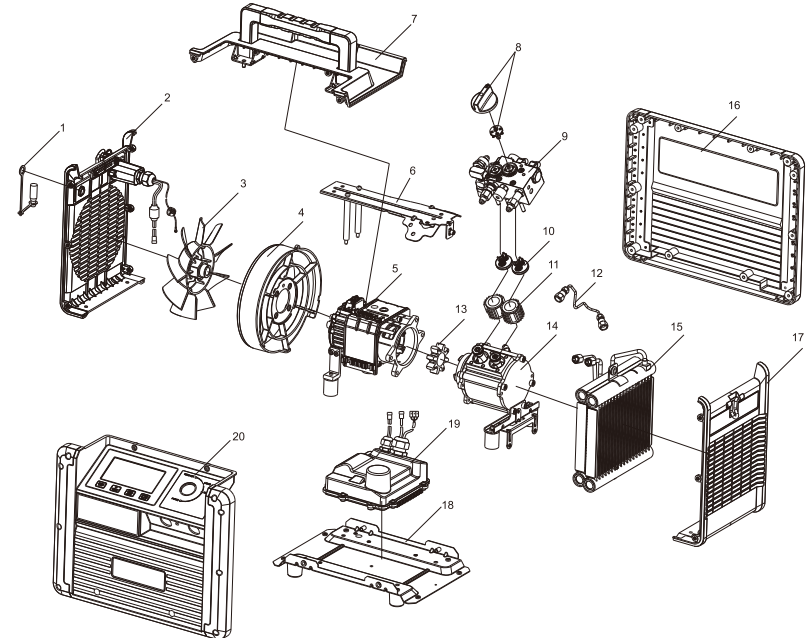

NO.	Parts name	NO.	Parts name
1	O.F.P Adaptor Assy	11	Cylinder
2	Left side Plate	12	Copper Pipe
3	Fan	13	Coupling
4	Wind Guide Cover	14	Compressor
5	Motor	15	Condenser
6	Support Assy	16	Rear Plate
7	Top Plate	17	Right Side Plate
8	Knob	18	Base
9	Control Assy	19	Motor Control Board (MCB)
10	Valve Assy	20	Front Side Plate with Digital Manifold Gauge

## WIRING DIAGRAM

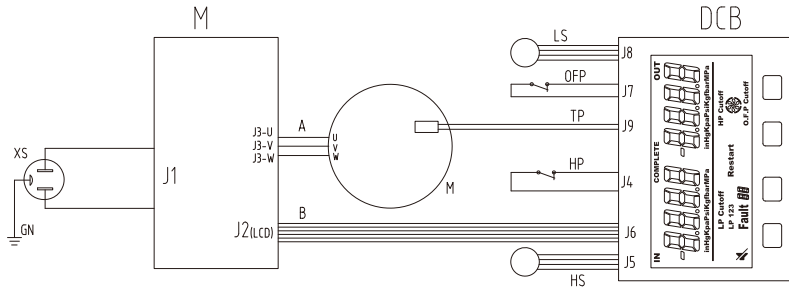

Graphics Code	ITEM
HS	High pressure sensor
M	Motor
MCB	Motor control board
XS	Socket
DCB	Digital gauge control board
LS	Low pressure sensor
OFP	Over filling protector
TP	Temperature protector
HP	High pressure switch

## OPERATING INSTRUCTION

### 1). Refrigerant hoses exhaust

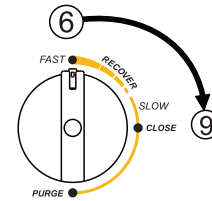
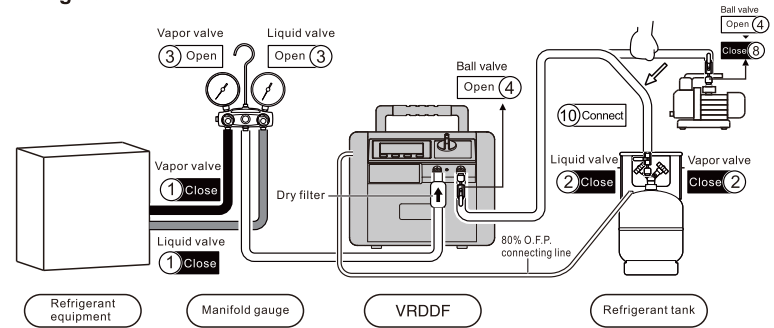

#### Preparation

It's required to use hoses with ball valves on this recovery machine. Connect the hose correctly and firmly (see diagram above)

1. Check the refrigeration device and make sure the gas valve and liquid valve are closed.
2. Check the refrigerant tank and make sure the gas valve and liquid valve are closed.
3. Open the gas valve and liquid valve of the manifold gauge.
4. Open the ball valves on the recovery machine outlet and valves on the hose connected to the outlet
5. Power on the recovery machine, the LCD screen will display the inlet and outlet pressures.
6. Turn the knob to "FAST".

#### Start

7. Start the vacuum pump and let it run until the recovery machine's display (low pressure) shows above -20inHg.
8. Close the ball valve of the vacuum pump hose which is connected to the refrigerant tank.
9. Turn the knob to "Close".
10. Connect the recovery machine outlet to the refrigerant tank with a hose.

## OPERATING INSTRUCTION

### 2). Recovery mode

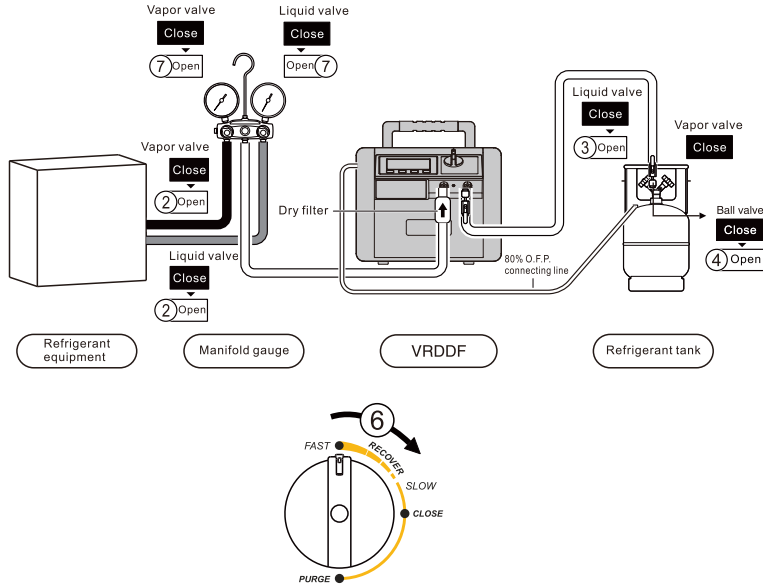

#### Preparation

Connect the hoses correctly and firmly.  
(Please refer to the connection diagram)  
Make sure all valves are closed.

1. Switch off the power of refrigerant equipment.
2. Open the vapor and liquid valves of refrigerant equipment.
3. Open the vapor valve of the refrigerant tank.
4. Open the ball valves on the hose connected to the recovery machine outlet

#### Start operation

5. Press the "START" button to start machine.
6. Turn the knob to "Recover".
7. a. If recover liquid refrigerant, please open the liquid valve of the manifold gauge.  
b. If recover vapor refrigerant, please open the vapor valve of the manifold gauge.

8. Recovery is completed when machine enters into a vacuum. In Automatic shutoff this would be at  $-20\text{inHg}$ .
- For the A3 refrigerant, when the pressure on the intake side reaches 0 bar, please stop running immediately.
9. When recovery is completed, you can run self-purging right away without powering off.

#### ▲ Notice

- ① If liquid hammer happens in the recovery, please slowly turn the knob to "Slow" position, let the reading of the low-pressure gauge drops until liquid hammer stops. Do not let the reading drop to zero, otherwise the inlet port will not pump.
- ② If it is difficult to start, turn to "CLOSE" when liquid, turn to "PURGE" when vapor, then press "START" to restart the machine, and turn to the required position.

## OPERATING INSTRUCTION

### 3). Self-purge mode

#### ▲ Notice

The unit must be purged every time after use;  
Liquid refrigerant remained may expand and damage the components and pollute the environment.

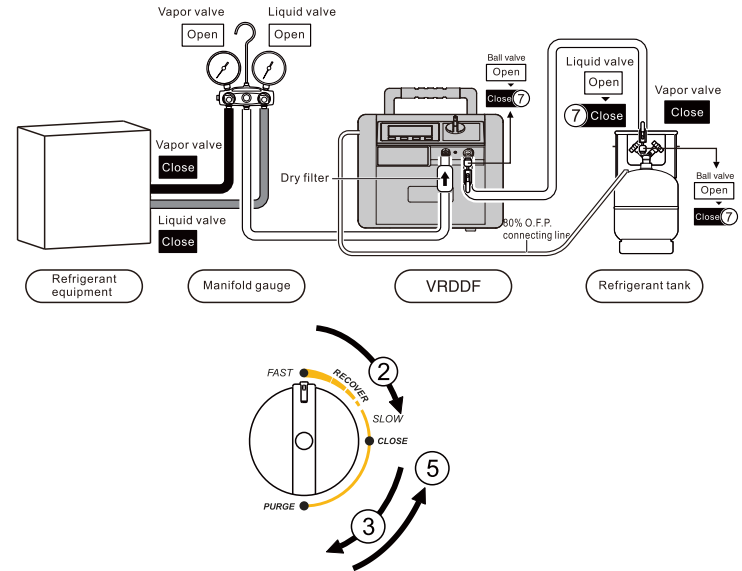

#### Start operation

1. The machine stops automatically after recovery finished based on LP cutoff setting.
2. Turn the knob to "Close", press "START" button to start the machine.
3. Turn the knob to "Purge" and start self purging.
4. The self purging mode will be finished when machine automatic stops or runs to certain vacuum level.

#### Finish operation

5. After confirming the machine has stopped, unplug the power cord from the charger to the power socket first, then unplug the cord from the charger to the recovery machine to avoid sparks.
6. Close the ball valves at both ends of the outlet hose.
7. Close the vapor valve of the tank.
8. Remove all the hoses and recycle them properly.
9. Turn the knob to "Close".



## OPERATING INSTRUCTION

### 4). Liquid push/pull mode

#### ▲ Notice

An electronic scale is needed to monitor the recovery process to prevent overfilling.

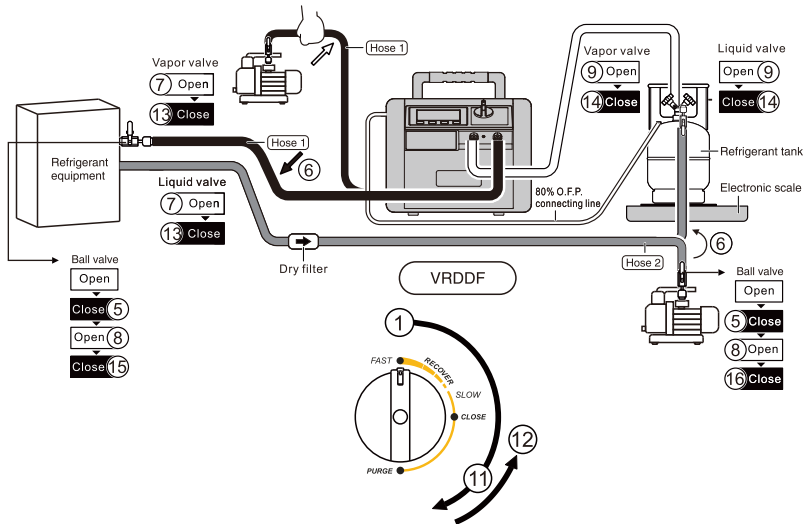

#### Preparation

- Connect the hoses correctly and firmly. (Please refer to the connection diagram) Make sure all valves are closed.
- Turn the knob to "FAST".
- Connect (hose 1) to the vacuum pump.
- Start the vacuum pump to pump the vacuum.
- Let the vacuum pump run for 20 secs, close the ball valve on (hose 1), turn off the vacuum pump, and remove the hose from the vacuum pump.
- Connect (hose 2) and repeat step 2, 3, 4
- Connect the hoses to the gas port of the system and the liquid port of the refrigeration tank.

#### Start operation

- Open the vapor valve, liquid valve of the HVAC system.
- Open the ball valves on the connecting (hose 1) and (hose 2)

- Open the vapor valve, liquid valve of the tank.
- Press "START" button to start machine, then it starts liquid push/pull mode.  
\* If the reading on the scale keeps the same or changes slowly, it means liquid in HVAC system has been recovered and vapor recovery mode can be underway.
- Turn the knob slowly to "Purge" and start self purging mode for the liquid.
- Turn the knob to "Close"
- Close the vapor valve, liquid valve of the HVAC system.
- Close the vapor valve, liquid valve of the tank.
- Close the ball valves on the hose connecting the recovery machine outlet and the system.
- Close the ball valves on the hose connecting the refrigerant tank and the system.
- Reconnect the hoses, and start recovery mode for the vapor.

#### Finish

## TROUBLE SHOOTING

PROBLEM	CAUSE	SOLUTION
LCD does not work after power is on	<ol style="list-style-type: none"> <li>Power cord is damaged.</li> <li>Inner connection is loose.</li> <li>Connect to J6 is damaged.</li> <li>Malfuction of circuit board.</li> </ol>	<ol style="list-style-type: none"> <li>Replace cord.</li> <li>Check the connection.</li> <li>Replace the connect.</li> <li>Replace MCB or DCN circuit board. Contact VALUE tech support</li> </ol>
Machine does not run after pressing START	<ol style="list-style-type: none"> <li>HP Cutoff, or OFF Cutoff works (screen shows.)</li> <li>Fault 2 or Fault3</li> <li>Fault 4 or Fault 8</li> <li>Fault 7</li> <li>Button is damaged.</li> <li>Circuit board is damaged.</li> </ol>	<ol style="list-style-type: none"> <li>Check if the connection between HP or OFF to DCB is good.                             <ol style="list-style-type: none"> <li>Adjust to correct voltage.</li> <li>If the voltage is correct, replace the MCB</li> </ol> </li> <li>If this happens only when starting the machine: for liquid recovery, turn the knob to "CLOSE", for gas recovery, turn the knob to "PURGE", press "START" again to start the machine, and turn the knob to "FAST".</li> <li>Only when inlet pressure is too high or fluid hammer happens, turn the knob to "SLOW"</li> <li>When error occurs at no load, power off the machine and check if the fan can be manually rotated. If yes, replace the control board. If not, send the machine back to the factory for repair.</li> <li>Check if the connection between TP and MCB is good. If good, contact VALUE tech support.</li> <li>Replace the front side plate with digital manifold gauge.</li> </ol>
Machine stops after running a period of time	<ol style="list-style-type: none"> <li>Misoperation causes HP Cutoff.</li> <li>Thermal protector is on and shows Fault 7.</li> <li>Refrigerant is 80% in the tank, and O.F.P Cutoff shows.</li> <li>low pressure protection switch is on.</li> </ol>	<ol style="list-style-type: none"> <li>Refer to section 6 of OPERATION MANUAL on page 3.</li> <li>When Fault 7 and Restart flash, press START.</li> <li>Replace the tank. When O.F.P Cutoff and Restart flash, press START.</li> <li>See refer to self-cleaning operation steps for self-cleaning.</li> </ol>
E1 shows at LP or HP	Pressure sensor is not connected well or is open circuit.	Check if the connection between LS or HS to DCB is good. If good, replace pressure sensor.
Slow recovery rate	<ol style="list-style-type: none"> <li>The pressure of the refrigerant tank is too high.</li> <li>The valve is not open enough.</li> <li>Piston ring of compressor is damaged.</li> </ol>	<ol style="list-style-type: none"> <li>Cooling the tank help decrease the pressure.</li> <li>Turn the knob towards "FAST".</li> <li>Contact VALUE tech support.</li> </ol>
Not evacuate	<ol style="list-style-type: none"> <li>Connection hose is loose.</li> <li>Machine leaks.</li> </ol>	<ol style="list-style-type: none"> <li>Tighten the connection hoses.</li> <li>Contact VALUE tech support.</li> </ol>

#### ▲ Attention

If you have the compressor repaired in any circumstances, please do a leak test before use and make sure there's no leak.

#### How to do the leak test:

- Block the outlet port with a ball valve, keep the inlet in connection with the atmosphere;
- Turn the knob to the "FAST" and start the machine. When the outlet pressure rises to 30bar, press the "STOP", and then turn the knob to the "PURGE".
- After standing for 3 minutes, observe the reading of the intake side pressure gauge value again. If the pressure drops  $\leq 1\text{bar}$  (0.1MPa/14.5PSI), there is no obvious leakage, then normal operations can be performed.
- After recycling, use 100% nitrogen to purge the refrigeration system, and then other operations can be performed.

