

VDM151B

Digital Multimeter User Manual

I. Overview

The VDM151B is a 6000-count digital multimeter with large LCD display and true RMS measurement functions. The maximum measuring capacitance is 100mF with fast response time of less than 12s; the NCV and continuity measurement have acousto-optic indication; In addition, it is equipped with the automatic fuse blown detection and high voltage false detection.

II. Features

- Large LCD, 6000 count display, true RMS measurement and fast ADC (3 times/s)
- Full-featured false detection protection for up to 1000V overvoltage surge, overvoltage and overcurrent alarm functions and automatic detection and alarm device of fuse blowing
- Extended measuring range, especially for capacitance (compared with similar products). The $\leq 100\text{mF}$ response time is within 12s.
- With non-contact voltage measurement (NCV), frequency measurement and temperature measurement.
- The max measurable voltage for AC is 750V/1kHz and for DC is 1000V. The max measurable current is 20A.
- Measurable high voltage frequency: 10Hz~10kHz (5V~750V)
- Supporting transistor measurement
- With backlight starting function which enables the multimeter to be used in dark conditions
- The power consumption of the multimeter is about 1.8 mA. The circuit has automatic power saving function. The micro power consumption in sleep state is only about 17 μA , which effectively extends the battery life to 500 hours.
- With current (AC/DC) mode memory function

III. Accessories

Open the package box and take out the multimeter. Please double check whether the following items are missing or damaged.

- User manual ----- 1 pc
- Test leads ----- 1 pair
- Temperature probe ----- 1 pc

If any of the above is missing or damaged, please contact your supplier immediately.

⚠ Note: Before using the meter, please read the safety instructions carefully.

IV. Safety Instructions

1. Safety Standards

- The multimeter is designed according to IEC61010-1: 2010, 61010-2-030:2010, 61010-2-033:2012, 61326-1:2013 and 61326-2-2:2013 standards.
- The multimeter conforms to CAT II 1000V, CAT III 600V, double insulation and material pollution grade II.

2. Safety Instructions

- Do not use the meter if the rear cover is not covered up or it will pose a shock hazard!
- Before use, please check and make sure the insulation layer of the meter and test leads is in good condition without any damage or broken wires. If you find the insulation layer of the meter housing is significantly damaged, or if you think the meter cannot function properly, do not use the meter.
- When using the meter, your fingers must be placed behind the finger guard ring of the test leads.
- Do not apply more than 1000V voltage between the meter terminal and the ground to prevent electric shock and damage to the meter.
- Be cautious when the measured voltage is higher than 60V (DC) or 30Vrms (AC) to avoid electric shock!
- The measured signal is not allowed to exceed the specified limit to prevent electric shock and damage to the meter!
- The range switch should be placed in the corresponding measuring setting.
- Never change the range setting when measuring to avoid damage to the meter!
- Do not change the internal circuit of the meter to avoid damage to the meter and user!
- The damaged fuse must be replaced with a fast-reaction one of same specifications.
- When the "LO" symbol appears on the LCD, please replace the battery in time to ensure measurement accuracy.
- Do not use or store the meter in high temperature and high humidity environments. The performance of the meter may be affected.
- Clean the meter casing with a damp cloth and mild detergent. Do not use abrasives or solvents!

V. Electrical Symbols

	Double insulation		AC
	Warning		High voltage hazard
	DC		Grounding

VI. General Specifications

- Max voltage between the input terminal and the ground: 1000Vrms
- Δ 20A terminal: 16A H 250V fast-acting fuse ($\Phi 6 \times 32\text{mm}$)
- Δ mA/ μA terminal: 600mA H 250V fast-acting fuse ($\Phi 6 \times 32\text{mm}$)
- Max display: 6099, "OL" appears when over range is detected, refresh rate is 3~4 times/s.
- Measuring range selection: Manual
- Backlight: Turned on by manual and turned off automatically after 30 seconds.
- Polarity: If negative polarity is input, the "-" symbol will be displayed.
- Data hold function: The bottom left corner of the LCD displays "H".
- Low battery indication: The bottom left corner of the LCD displays "LO".
- Acousto-optic indication: The continuity and NCV measurement are accompanied by the beep and LED illumination indication.
- Internal battery: AAA battery 1.5V $\times 2$
- Operating temperature: 0 $^{\circ}\text{C}$ ~40 $^{\circ}\text{C}$ (32 $^{\circ}\text{F}$ ~104 $^{\circ}\text{F}$)
Storage temperature: -10 $^{\circ}\text{C}$ ~50 $^{\circ}\text{C}$ (14 $^{\circ}\text{F}$ ~122 $^{\circ}\text{F}$)
Relative humidity: 0 $^{\circ}\text{C}$ ~below 30 $^{\circ}\text{C}$ $\leq 75\%$, 30 $^{\circ}\text{C}$ ~40 $^{\circ}\text{C}$ $\leq 50\%$
Operating altitude: 0~2000m
- Dimensions: 183mm \times 88mm \times 56mm
- Weight: About 346g (including batteries)

VII. External Structure (Picture 1)

- Protecting jacket
- LCD
- Functional buttons
- Transistor test port
- Range switch
- Input terminals
- Hook
- Test lead slot
- Battery cover
- Holder

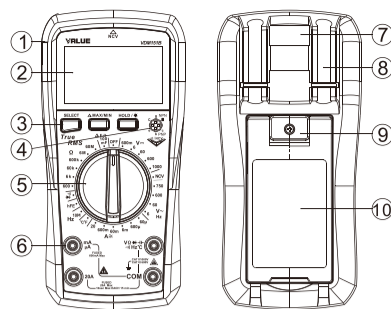

Picture 1

VIII. Button Function

- **SELECT** button: Press this button to switch the diode/continuity measuring range, Celsius/Fahrenheit, AC voltage/frequency and AC/DC measuring range. Each time you press it, the corresponding measuring range will be switched alternately.
- **Δ MAX/MIN** button: Press this button in the capacitance setting to clear the base; press this button in the voltage and current settings to display the "MAX/MIN" value.
- **HOLD/ON/OFF** button: Press this button to enter/cancel the data hold mode; Press this button for $\geq 2\text{s}$ to turn on/off the backlight.

IX. Operating Instructions

Please first check the internal AAA 1.5V $\times 2$ batteries. If the battery is low when the device is turned on, the "LO" symbol will appear on the display. To ensure measurement accuracy, users need to replace batteries in time before use. Please also pay special attention to the warning sign "⚠" beside the test lead terminals, which indicates that the measured voltage or current must not exceed the values listed on the device.

1. DC/AC Voltage Measurement (Picture 2)

- Turn the range switch to the AC/DC voltage position;
- Insert the red test lead into the "V Ω " jack, black into the "COM" jack, and make the probes in contact with both ends of the measured voltage (parallel connection to the load);
- Read the test results on the display.

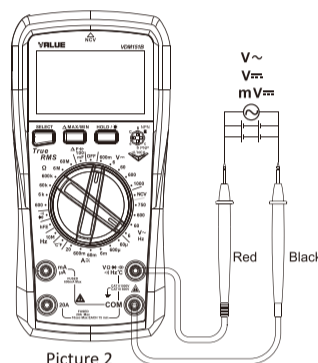

Picture 2



Note:

- The DCV measuring voltage should not be higher than 1000Vrms and ACV should not be higher than 750Vrms. Although it is possible to measure higher voltage, it may damage the meter and hurt the user! If the range of the measured voltage is unknown, select the maximum range and then accordingly reduce (If the LCD displays OL, it indicates that the voltage is over range). The input impedance of the meter is 10M Ω . This load effect may cause measurement error
- when measuring the high impedance circuit. If the measured impedance is $\leq 10\text{k}\Omega$, the error can be ignored ($\leq 0.1\%$).
- Be cautious to avoid electric shock when measuring high voltage. Test known voltage before use to confirm if the meter functions properly!

2. Resistance Measurement (Picture 3)

- Turn the range switch to the resistance measurement position;
- Insert the red test lead into the "V Ω " jack, black into the "COM" jack, and make the probes in contact with both ends of the measured resistance (parallel connection to the resistance);
- Read the test results on the display.

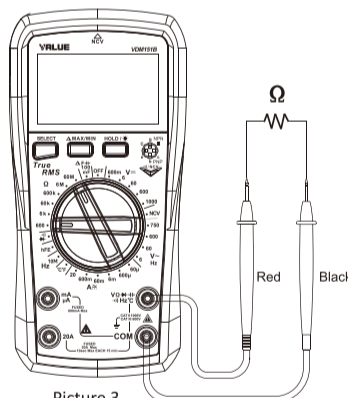

Picture 3

Note:

- Before measuring the resistance online, switch off the power supply of the circuit, and fully discharge all capacitors to avoid damage to the meter and user.
- If the resistance is not less than 0.5 Ω when the test leads are shorted, please check if the test leads are loose or abnormal.
- If the measured resistor is open or the resistance exceeds the maximum range, the "OL" symbol will appear on the display.
- When measuring low resistance, the test leads will produce 0.1 Ω ~0.2 Ω measurement error. To obtain the final accurate value, the resistance value of the red and black test leads when they are short-circuited should be subtracted from the measured resistance value.
- When measuring high resistance, it is normal to take a few seconds to steady the readings.
- Do not input voltage higher than DC 60V or AC 30V.

3. Continuity Measurement (Picture 4)

- Turn the range switch to the continuity measurement position;
- Insert the red test lead into the "V Ω " jack, black into the "COM" jack, and make the probes in contact with the two test points;
- Measured resistance $> 51\Omega$: The circuit is broken; buzzer makes no sound. Measured resistance $\leq 10\Omega$: The circuit is in good conduction status; buzzer beeps continuously with a red LED indication.

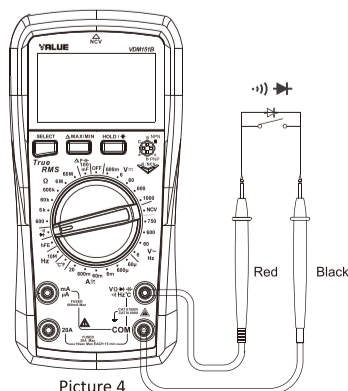

Picture 4

⚠ Note:

- Before measuring the continuity online, switch off the power supply of the circuit, and fully discharge all capacitors to avoid damage to the meter and user.

4. Diode Measurement (Picture 4)

- Turn the range switch to the diode measurement position;
- Insert the red test lead into the "V Ω " jack, black into the "COM" jack, and make the probes in contact with the two endpoints of the PN junction;
- If the diode is open or its polarity is reversed, the "OL" symbol will appear on the display. For the silicon PN junction, the normal value is generally about 500~800 mV (0.5 to 0.8 V). The moment the reading is displayed the buzzer beeps once. Long beep indicates the short circuit of the test lead.

⚠ Note:

- Before measuring the PN junction online, switch off the power supply of the circuit, and fully discharge all capacitors to avoid damage to the meter and user.
- Diode test voltage range: About 3V/1.0mA

5. Transistor Magnification Measurement (hFE) (Picture 5)

- Turn the range switch to the "hFE" position;
- Insert the base (B), emitter (E) and collector (C) of the transistor (PNP or NPN type) to be tested into the four-pin test port accordingly. The hFE approximation of the transistor under test is shown on the display.

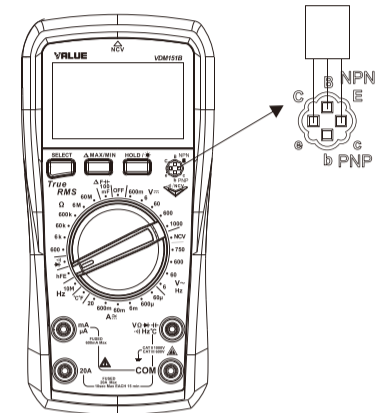

Picture 5

6. Capacitance Measurement (Picture 6)

- Turn the range switch to the capacitance measurement position;
- Insert the red test lead into the "V Ω " jack, black into the "COM" jack, and make the probes in contact with the two endpoints of the capacitance;
- Read the test results on the display. When there is no input, the meter displays a fixed value (intrinsic capacitance). For small capacitance measurement, this fixed value must be subtracted from the measured value to ensure measurement accuracy. Or users can choose the relative measurement function " Δ " (REL) to automatically subtract the intrinsic capacitance.

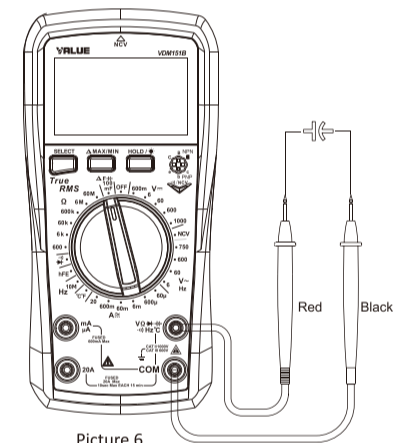

Picture 6

⚠ Note:

- If the measured capacitor is short-circuited or the capacitance exceeds the maximum range, the "OL" symbol will appear on the display. When measuring high capacitance, it is normal to take a few seconds to steady the readings. Before measuring, fully discharge all capacitors (especially for capacitors with high voltage) to avoid damage to the meter and user.

7. AC/DC Measurement (Picture 7)

- Turn the range switch to the DC (AC) position;
- Insert the red test lead into the "mA μ A" or "A" jack, black into the "COM" jack, and connect the test leads to the power supply or circuit to be tested in series;
- Read the test results on the display.

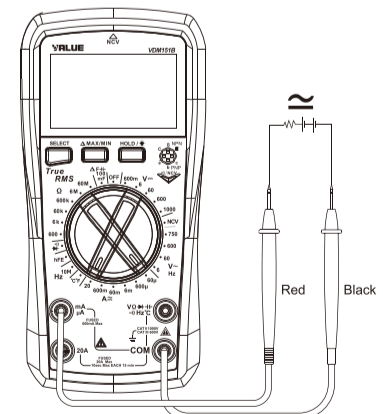

Picture 7

⚠ Note:

- Before connecting the meter to the circuit in series, switch off the power supply in the circuit, and check the position of the input terminal and its range switch carefully to ensure the correctness.
- If the range of the measured current is unknown, select the maximum range and then accordingly reduce.
- When the "mA μ A" and "A" input jacks are overloaded or mishandled, the built-in fuse will be blown; if the mA μ A fuse is blown, the LCD will flash "FUSE" accompanied by the beep. Please replace the blown fuse before continuing to use.
- When measuring current, do not connect the test leads to any circuit in parallel to avoid damage to the meter and user.
- When the measured current is close to 20A, each measurement time should be less than 10s and the rest interval should be more than 15 minutes!

8. Temperature Measurement (°C/°F Measurement, Picture 8)

- 1) Turn the range switch to the temperature measurement position;
- 2) Insert the plug of the K-type thermocouple into the meter, and fix the temperature sensing end of the probe on the object to be tested; read the temperature value on the display after it is steady.

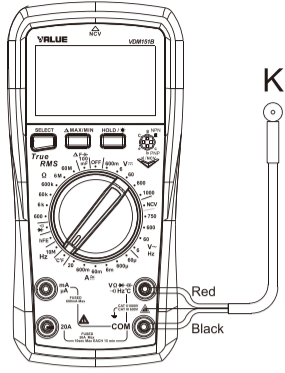

Picture 8

△ Note:

“OL” symbol appears when the meter is turned on. Only K-type thermocouple/temperature sensor is applicable (The measured temperature should be less than 250 °C/482 °F).
°F=°C*1.8+32

9. Frequency Measurement (Picture 9)

- 1) Turn the range switch to the Hz position;
- 2) Insert the red test lead into the “VΩ” jack, black into the “COM” jack, and connect the test leads to both ends of the signal source in parallel (The measurement range is 10Hz~10MHz);
- 3) Read the test results on the display.

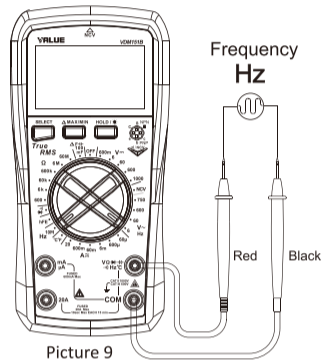

Picture 9

△ Note:

- The output signal of the measurement is required to be lower than 30V; otherwise, the measurement accuracy will be affected.
- When measuring the frequency of the voltage higher than 30V, please turn the range switch to the ACV position and switch by SELECT to measure it.

10. Non-contact AC Electric Field Sensing (Picture 10)

- 1) To sense whether there is AC voltage or electromagnetic field in the space, please turn the range switch to (NCV) position;
- 2) Bring the front end of the meter close to a charged object to start sensing. The LCD indicates the intensity of the electric field sensing by the segment, and the segment “-” is displayed in five levels. The more the segments (up to four segments) are displayed, the higher the frequency of the beep. At the same time, the red LED flashes. As the electric field is measured, the buzzer and red LED synchronously change the frequency of beeping and flashing. The higher the electric field intensity is, the higher the frequency of the buzzer beeping and LED flashing, and vice versa.

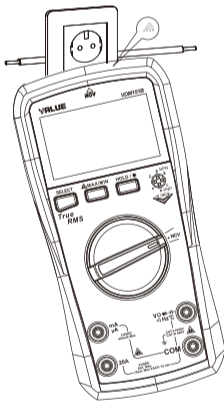

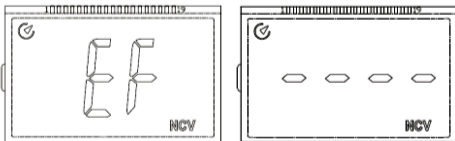

Picture 10

- 3) The diagram of the segment indicating the intensity of the electric field sensing is shown below.



11. Others

- The meter cannot enter the normal measurement state until its full display for about 2s after the starting up.
- During the measurement, if there is no operation of the range switch for 15 minutes, the meter will automatically shut down to save power. You can wake it up by pressing any button or turning the range switch, and the buzzer should beep once (about 0.25s) for indication. To disable auto shutdown, press and hold the SELECT button to switch on the meter while turning the knob to the OFF position.
- Buzzer warning:
 - a. Input DCV ≥1000V/ACV ≥750V: The buzzer beeps continuously indicating that the range is at its limit.
 - b. Current >20A (DC/AC): The buzzer beeps continuously indicating that the range is at its limit.
 About 1 minute before the auto shutdown, the buzzer will make five consecutive beeps; before shutdown, the buzzer will make one long beep. Low battery detection: When the battery is lower than about 2.5V, the low battery symbol “” appears. But the meter still works. When the battery is lower than about 2.2V, only the low battery symbol “” will be displayed after the meter is switched on. And the meter cannot work.

X. Technical Index

Accuracy: ± (a% of reading + b digits), 1 year warranty
Ambient temperature: 23 °C±5 °C (73.4 °F±9 °F)
Relative humidity: ≤75%

△ Note:

To ensure measurement accuracy, operating temperature should be within 18°C ~28 °C and the fluctuation range should be within ±1 °C. Temperature <18 °C or >28 °C: Add temperature coefficient error 0.1 x (specified accuracy)/ °C.

1. DCV Measurement

Range	Resolution	Accuracy
600.0mV	0.1mV	± (0.5%+5)
6.000V	0.001V	± (0.5%+5)
60.00V	0.01V	± (0.7%+3)
600.0V	0.1V	
1000V	1V	

△ Note:

- Input impedance: About 10MΩ (The reading might be unstable at mV range when no load is connected, and it becomes stable once the load is connected, ≤±3 digits)
- Max input voltage: ±1000V
Input voltage ≥1010V: “OL” appears on the display.
- Overload protection: 1000Vrms (DC/AC)

2. ACV Measurement

Range	Resolution	Accuracy
6.000V	0.001V	± (1.0%+3)
60.00V	0.01V	± (0.8%+3)
600.0V	0.1V	
750V	1V	± (1.0%+10)

△ Note:

- Input impedance: About 10MΩ
- Frequency response: 40Hz~1000Hz, sine wave RMS (mean response)
- Max input voltage: AC 750V
Input voltage ≥761V: “OL” appears on the display.
- Measuring high voltage frequency: 10Hz~10kHz (5V~750V)
High voltage frequency>12kHz: “OL” appears on the display.
- Overload protection: 1000Vrms (DC/AC)
- For the non-sinusoidal AC crest factor, the additional error is increased as follows:
 - a) Add 3% when crest factor is 1~2
 - b) Add 5% when crest factor is 2~2.5
 - c) Add 7% when crest factor is 2.5~3



3. Resistance Measurement

Range	Resolution	Accuracy
600.0Ω	0.1Ω	± (0.8%+5)
6.000kΩ	0.001kΩ	± (0.8%+3)
60.00kΩ	0.01kΩ	
600.0kΩ	0.1kΩ	
6.000MΩ	0.001MΩ	± (3.0%+10)
60.00MΩ	0.01MΩ	

△ Note:

- Measurement result = reading of resistance – reading of shorted test leads
- Overload protection: 1000Vrms (DC/AC)

4. Continuity and Diode Measurement

Range	Resolution	Remark
	0.1Ω	Open circuit: Resistance >50Ω, no beep Well-connected circuit: Resistance ≤10Ω, consecutive beep
	0.001V	Open circuit voltage: About 3V (test current is about 1.0mA) Silicon PN junction normal voltage: About 0.5~0.8V

△ Note:

Overload protection: 1000Vrms (DC/AC)

5. Capacitance Measurement

Range	Resolution	Accuracy
6.000nF	0.001nF	In REL mode: ±(4.0%+10)
60.00nF	0.01nF	± (4%+10)
600.0nF	0.1nF	
6.000μF	0.001μF	± (3%+10)
60.00μF	0.01μF	
600.0μF	0.1μF	
6.000mF	0.001mF	± (5.0%+10)
60.00mF	0.01mF	± (10.0%)
100.0mF	0.1mF	

△ Note:

Overload protection: 1000Vrms (DC/AC)
Measured capacitance ≤100nF: It is recommended to select relative measurement (REL mode) for ensuring accuracy.

6. Temperature Measurement

Range		Resolution	Accuracy
°C	-40~1000°C	-40~40°C	±3°C
		>40~500°C	± (1.0%+3)
		>500~1000°C	± (2.0%+3)
°F	-40~1832°F	-40~104°F	±5°F
		>104~932°F	± (1.5%+5)
		>932~1832°F	± (2.5%+5)

△ Note:

- Overload protection: 1000Vrms (DC/AC)
- The measured temperature should be less than 250 °C/482 °F.

7. DCA Measurement

Range	Resolution	Accuracy
60.00μA	0.01μA	± (0.8%+8)
600.0μA	0.1μA	
6.000mA	0.001mA	
60.00mA	0.01mA	± (1.2%+5)
600.0mA	0.1mA	
20.00A	0.01A	± (2.0%+5)

△ Note:

Input ≥20A: Alarm sound
Input >20.1A: “OL” appears on LCD.
Overload protection: 1000Vrms

8. ACA Measurement

Range	Resolution	Accuracy
60.00μA	0.01μA	± (1.0%+12)
600.0μA	0.1μA	
6.000mA	0.001mA	
60.00mA	0.01mA	± (2.0%+3)
600.0mA	0.1mA	± (3.0%+5)
20.00A	0.01A	

△ Note:

- Frequency response: 40Hz~1000Hz
- Display: RMS
- Accuracy guarantee range: 5~100% of range, short circuit allows least significant digit <2.
- Input ≥20A: Alarm sound
Input >20.1A: “OL” appears on LCD.
Overload protection: Reference the overload protection of DC measurement.

9. Frequency Measurement

Range	Resolution	Accuracy
9.999Hz~9.999MHz	0.001Hz~0.001MHz	± (0.1%+5)

△ Note:

- Overload protection: 1000Vrms (DC/AC)
Input amplitude:
 - ≤100kHz: 100mVrms ≤input amplitude ≤30Vrms
 - >100kHz~1MHz: 200mVrms ≤input amplitude ≤30Vrms
 - >1MHz: 600mVrms ≤input amplitude ≤30Vrms

XI. Maintenance

△ Warning: Before opening the rear cover of the meter, switch off the power supply (remove the test leads from the input terminals and the circuit).

1. General Maintenance

- Clean the meter casing with a damp cloth and mild detergent. Do not use abrasives or solvents!
- If there is any malfunction, stop using the meter and send it for maintenance.
- The maintenance and service must be implemented by qualified professionals or designated departments.

2. Battery/Fuse Replacement (Picture 11)

- 1) Replace the battery immediately when the low battery symbol “” appears on the LCD, otherwise the measurement accuracy might be affected. Battery specification: AAA 1.5Vx2 batteries
- Turn the range switch to the “OFF” position, remove the test leads from the input jacks, and take off the protecting jacket.
- Battery replacement: Use a screwdriver to unscrew the screw on the battery cover (top), and remove the cover to replace the battery. Pay attention to the positive and negative polarity when installing the new battery.
- 2) During the operation of the meter, if the fuse is blown by mismeasuring voltage or overcurrent, some functions of the meter may not work. Replace the fuse immediately.
- Turn the range switch to the “OFF” position, remove the test leads from the input jacks, and take off the protecting jacket.
- Unscrew the screw on the battery cover with a screwdriver to replace the blown fuse.
- Fuse specification: F1 Fuse 0.6A/250V Φ6 × 32 mm ceramic tube
F2 Fuse 16A/250V Φ6 × 32 mm ceramic tube

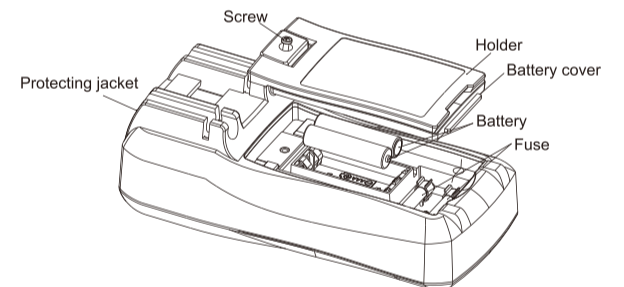

Picture 11